

**OPERATOR MANUAL**

**Lab 250 and Lab 110  
Life Sciences Small Sterilizers**

**(11/13/06)**

**P387352-364**

# A WORD FROM STERIS

---

This manual contains important information on proper use of this Lab 250 and 110 Series Life Sciences Small Steam Sterilizer. **All personnel involved in the use of this equipment must carefully review and comply with the Warnings, Cautions and instructions contained in this manual.** These instructions are important to protect the health and safety of personnel operating the sterilizer and should be retained in a conveniently accessible area for quick reference.

This sterilizer is specifically designed to process goods using only the cycles as specified in this manual. If there is any doubt about a specific material or product, contact the manufacturer of the product for the recommended sterilization technique.

STERIS carries a complete line of accessories for use with this sterilizer to simplify, organize, and verify sterility of the sterilization process. Instrument trays and biological/chemical monitoring systems are all available to fulfill a typical life-science facility's processing needs. Contact a STERIS representative to review these possibilities.

---

## Service Information

---

A thorough preventive maintenance program is essential for safe and proper sterilizer operation. Comprehensive instructions for routine preventive maintenance can be found in the *ROUTINE MAINTENANCE* section provided. You are encouraged to contact STERIS concerning our Preventive Maintenance Agreement. Under the terms of this agreement, preventive maintenance, adjustments, and replacement of worn parts are done on a scheduled basis to help ensure equipment performance at peak capability and to help avoid untimely or costly interruptions. STERIS maintains a staff of well equipped, factory-trained technicians to provide this service, as well as expert repair services. Please call STERIS to learn about additional details.

---

## Indications for Use

---

Designed for use in laboratory and industrial applications. Three sterilizer configurations are available.

**Gravity** – designed for sterilization of non-porous heat- and moisture- stable goods, sterilization of liquids and media in borosilicate glass containers with vented closures, and decontamination of supplies after laboratory procedures. The gravity sterilizer is equipped with gravity and liquid cycles.

**Prevacuum** (Optional) – designed for fast, efficient sterilization of porous, heat- and moisture- stable materials, in addition to the same sterilization capabilities as the gravity sterilizer. The prevacuum sterilizer is equipped with prevacuum, gravity, liquid, leak test, and daily air removal test cycles.

**Isothermal** (Optional) – designed for low temperature sterilization of heat-sensitive and heat-coagulable materials in addition to the same sterilization capabilities as the gravity sterilizer. The isothermal sterilizer is equipped with isothermal, gravity, and liquid cycles.

Each configuration includes choice of a single or double door, for open or recessed mounting.

(Recessed two-wall mounting not available for 16 x 16 x 26" (406 x 406 x 660 mm) double door sterilizers).

**Table 1. Recommended Loads by Sterilizer Size**

	<b>Volume (Liters)</b>
16 x 16 x 26" (406 x 406 x 660 mm)	109
20 x 20 x 38" (508 x 508 x 965 mm)	249

**Table 2. Sterilizer Configurations**

The 16 x 16" (406 x 406 mm) and 20 x 20: (508 x 508 mm) Medium Steam Sterilizers are offered in the following configurations:

**Configurations**

16 x 16 x 26" (406 x 406 x 660 mm)	Single Door
20 x 20 x 38" (508 x 508 x 965 mm)	Single Door
16 x 16 x 26" (406 x 406 x 660 mm)	Double Door
20 x 20 x 38" (508 x 508 x 965 mm)	Double Door

---

---

**Advisory**

---

---

This sterilizer is specifically designed to only process goods using the cycles as specified in this manual. If there is any doubt about a specific material or product, contact the manufacturer of that product for the recommended sterilization technique.

A summary of the safety precautions to be observed when operating and servicing this equipment can be found in *SECTION 1* of this manual. Do not operate or service the equipment until becoming familiar with this information. Do not attempt to operate this equipment in a manner not specified by the manufacturer.

Any alteration of the sterilizer not authorized or performed by STERIS which could affect its operation will void the warranty, could adversely affect sterilization efficacy, could violate national, state, and local regulations and jeopardize insurance coverage.

Manufactured Exclusively by:

STERIS Mexico  
Avenida Avante 790  
Parque Industrial Guadalupe  
Guadalupe, Nuevo Leon, Mexico C.P. 67190  
[www.steris.com](http://www.steris.com)

# TABLE OF CONTENTS

Section	Paragraph	Page
<b>1</b>	<b>LISTING OF WARNINGS AND CAUTIONS .....</b>	<b>1-1</b>
	Definition of Symbols .....	1-4
<b>2</b>	<b>INSTALLATION VERIFICATION .....</b>	<b>2-1</b>
	2.1 Installation Checklist .....	2-1
	2.1.1 Service Clearance .....	2-1
	2.1.2 Plumbing Services .....	2-1
	2.2 Technical Specifications .....	2-2
	2.2.1 Electrical Service .....	2-2
	2.2.2 Sterilizer Final Check .....	2-2
	2.2.3 Cycle Operation .....	2-2
	2.2.4 Overall Size and Weight .....	2-2
	2.2.5 Electrical Service .....	2-3
	2.2.6 Environmental Conditions .....	2-3
	2.2.8 Environmental Conditions .....	2-3
	2.2.7 Utility Requirements For Units Equipped With Optional Electric Steam Sterilizers .....	2-3
<b>3</b>	<b>TECHNIQUES OF STERILIZATION .....</b>	<b>3-1</b>
	3.1 Recommended Sterilization Variables .....	3-1
	3.1.1 Prevacuum Cycle .....	3-1
	3.1.2 Gravity Cycle .....	3-1
	3.1.3 Liquid Cycle .....	3-2
	3.2 Control Measures for Verifying Sterilization Process .....	3-3
	3.2.1 Biological Monitors .....	3-3
	3.2.2 Testing for Prevacuum Efficiency .....	3-3
	3.3 Bowie-Dick Test .....	3-4
	3.4 Vacuum Leak Test .....	3-4
	3.5 Recommendations for the Sterilization Process .....	3-5
	3.6 Techniques of Sterilization for Liquid Cycle .....	3-6
	3.7 Recommendations for Sterilizing Liquids .....	3-6
<b>4</b>	<b>OPERATOR INSTRUCTIONS .....</b>	<b>4-1</b>
	4.1 Component Identification .....	4-1
	4.1.1 Main Power Disconnect Switch .....	4-2
	4.1.2 Supply Valves .....	4-2
	4.2 Control Panel .....	4-3
	4.2.1 Touch Screen .....	4-3
	4.2.2 Printer (Optional) .....	4-3
	4.2.3 Operating Mode .....	4-5
	4.2.4 Cycle Start .....	4-5
	4.2.5 End-of-Cycle Performance Summary .....	4-5
	4.2.6 Alarm Condition .....	4-5
	4.3 Manual Operation of Manual Door .....	4-6
	4.4 Emergency Door Operation .....	4-7
	4.5 Optional Electric Steam Generator .....	4-9

Section	Paragraph	Page
<b>5</b>	<b>CONTROL INTERFACE .....</b>	<b>5-1</b>
5.1	General Description .....	5-1
5.1.1	Information and Help .....	5-1
5.1.2	Password Entry .....	5-2
5.2	Operating Modes .....	5-4
5.2.1	Gravity Sterilizer Only .....	5-4
5.2.2	Prevac Sterilizer Only (Optional) .....	5-7
5.2.3	Isothermal Sterilizer Only (Optional) .....	5-10
5.3	Status Buttons .....	5-13
5.4	Printer Operation (Optional) .....	5-17
5.4.1	Printer Operation (Optiona Cybertech Printer) .....	5-17
5.4.2	Printer Operation (Optiona Mylox Printer) .....	5-18
5.5	Compact Flash Card .....	5-18
5.6	RS232 Download To PC .....	5-20
<b>6</b>	<b>STERILIZER OPERATION .....</b>	<b>6-1</b>
6.1	Before Operating Sterilizer .....	6-1
6.1.1	Load Sterilizer .....	6-3
6.1.2	Sterilizer Equipped with Loading Car .....	6-3
6.2	Gravity Cycle .....	6-5
6.3	Prevac Cycle (Optional) .....	6-11
6.4	Liquid Cycle .....	6-18
6.5	Isothermal Cycle (Optional) .....	6-24
6.6	Bowie-Dick Warmup Cycle (Only On Prevacuum Sterilizers) .....	6-29
6.7	Bowie-Dick Cycle (Only On Prevacuum Sterilizers) .....	6-34
6.8	Leak Test Cycle (Only On Prevacuum Sterilizers) .....	6-40
6.9	Cycle Abort .....	6-46
6.10	Double Doors .....	6-47
6.11	Load Probe and Fo Sterilization (Sterilizers With Load Probe Only) .....	6-47
6.11.1	F <sub>0</sub> Sterilization .....	6-47
6.12	Separate Steam Feed Option .....	6-48
6.13	Supervisor Mode .....	6-48
6.13.1	Cycle Parameters .....	6-48
6.13.2	Too Long In Step .....	6-59
6.13.3	Cycle Count .....	6-62
6.13.4	Units .....	6-62
6.13.5	Set Time and Date .....	6-63
6.13.6	Set Passwords .....	6-63
6.13.7	Machine Number .....	6-65
6.13.8	Default Values .....	6-65

Section	Paragraph	Page
<b>7</b>	<b>ALARMS</b>	<b>7-1</b>
<b>8</b>	<b>ROUTINE MAINTENANCE</b>	<b>8-1</b>
8.1	Service Mode	8-1
8.1.1	Calibration	8-1
8.1.2	I/O Test	8-7
8.1.3	Serial Number	8-8
8.1.4	Configure Machine	8-8
8.2	Change Printer Paper Roll (Cybertech Printer)	8-11
8.3	Change Printer Paper Roll (Mylox Printer)	8-13
8.4	Change Printer Ribbon (Mylox Printer)	8-14
8.5	Clean Chamber Drain Strainer	8-15
8.6	Flush Chamber Drain	8-15
<b>9</b>	<b>PREVENTIVE MAINTENANCE</b>	<b>9-1</b>
9.1	Maintenance Schedule	9-1
9.2	Spare Parts	9-3
<b>10</b>	<b>APPENDIX A</b>	<b>10-1</b>
10.1	PLC Specifications	10-1

# LISTING OF WARNINGS AND CAUTIONS

1

The following is a list of the safety precautions which must be observed when operating this equipment. WARNINGS indicate the potential for danger to personnel, and CAUTIONS indicate the potential for damage to equipment. These precautions are repeated (in whole or in part), where applicable, throughout the manual. This is a listing of all safety precautions appearing in the manual. Carefully read them before proceeding to use or service the unit.

---

## WARNING—ELECTRIC SHOCK AND BURN HAZARD:

- ⚠ Disconnect all utilities to sterilizer before servicing. Do not service the sterilizer unless all utilities have been properly locked out. Always follow appropriate Lockout-Tagout and electrical safety-related work practice standards.

---

## WARNING—PERSONAL INJURY HAZARD:

- ⚠ When closing the chamber door, keep hands and arms out of the door opening and make sure opening is clear of obstructions.

---

## WARNING—BURN HAZARD:

- ⚠ Sterilizer, rack/shelves, and loading car will be hot after cycle is run. Always wear protective gloves and apron when removing a processed load. Protective gloves and apron must be worn when reloading sterilizer following the previous cycle.
- ⚠ Steam may be released from the chamber when door is opened. Step back from the sterilizer each time the door is opened to minimize contact with steam vapor.
- ⚠ Do not attempt to open the sterilizer door if a WATER IN CHAMBER ALARM condition exists. Call a qualified service technician before attempting to use sterilizer further.
- ⚠ After manual exhaust, steam may remain inside the chamber. Always wear protective gloves, apron, and a face shield when following emergency procedure to unload sterilizer. Stay as far back from the chamber opening as possible when opening the door.
- ⚠ Allow sterilizer to cool to room temperature before performing any cleaning or maintenance procedures.
- ⚠ Failure to shut off the steam supply when cleaning or replacing strainers can result in serious injury.
- ⚠ Jacket pressure must be 0 psig (0 bar) before beginning work on the steam trap.
- ⚠ Proper testing of the safety valve requires the valve to be operated under pressure. Exhaust from the safety valve is hot and can cause burns. Proper safety attire (gloves, eye protection, insulated overall) is required. Testing is to be performed by qualified service personnel only.
- ⚠ When sterilizing liquids, to prevent personal injury or property damage resulting from bursting bottles and hot fluid, you must observe the following procedures:
  - Use LIQUID cycle only; no other cycle is safe for processing liquids.
  - Use only vented closures; do not use screw caps or rubber stoppers with crimped seal.
  - Use only Type 1 borosilicate glass bottles; do not use ordinary glass bottles or any container not designed for sterilization.
  - Do not allow hot bottles to be jolted; this can cause hot-bottle explosions. Do not move bottles if any boiling or bubbling is present.

---

**WARNING–BURN HAZARD:**

- ⚠ Sterilizer operator may be severely burned by scalding water if the water level control malfunctions. The steam generator level control may malfunction if the supply water exceeds 26,000 ohms/cm (38.5 microohms) conductivity minimum. Do not connect treated water (e.g., distilled, reverse osmosis, deionized) unless water resistivity is determined to be acceptable. If water exceeds 26,00 ohms/cm, contact STERIS for information concerning modifications required to the generator control system.

---

**WARNING – EXPLOSION HAZARD:**

- ⚠ This sterilizer is not designed to process flammable compounds.

---

**WARNING – SLIPPING HAZARD:**

- ⚠ To prevent falls, keep floors dry by immediately wiping up any spilled liquids or condensation in sterilizer loading or unloading area.

---

**WARNING – PERSONAL INJURY AND/OR EQUIPMENT DAMAGE HAZARD:**

- ⚠ Regularly scheduled preventive maintenance is required for safe and reliable operation of this equipment. Contact STERIS to schedule preventive maintenance.
- ⚠ Repairs and adjustments to this equipment must be made only by fully qualified service personnel. Maintenance performed by inexperienced, unqualified persons or installation of unauthorized parts could cause personal injury or result in costly equipment damage.
- ⚠ The configure machine section should only be done in the factory or by a qualified service technician.

---

**WARNING – STERILITY ASSURANCE HAZARD:**

- ⚠ Load sterility may be compromised if the biological indicator or air leak test indicates a potential problem. If these indicators show a potential problem, refer the situation to a qualified service technician before using the sterilizer further.







---

---

## CAUTION – POSSIBLE EQUIPMENT DAMAGE:

- ⚠ Gasket must be fully retracted prior to operating sterilizer door.
- ⚠ Do not try to raise or lower door rapidly as fast operation may damage the manual door mechanism.
- ⚠ If 0 dry time is selected, sterilizer automatically initiates a vapor removal phase in place of drying. This phase can still draw a vacuum to 5 inHg. Consult device manufacturer's recommendations to verify devices being processed can withstand this depth of vacuum.
- ⚠ Lifting the chamber float switch when cleaning the chamber may cause the sterilizer control to initiate a **Chamber Flooded** alarm. If this alarm condition occurs, the operator must turn the control power OFF then ON to clear the alarm. The control power switch is located in the mechanical area at the side of the sterilizer. Placing the sterilizer in standby does not clear this alarm.
- ⚠ Allow thermostatic traps to cool down to room temperature before removing cover. Since there is nothing to limit expansion, the bellows may rupture or fatigue if trap is opened while hot.
- ⚠ Actuation at less than 75% of rated pressure can allow debris to contaminate the seat and cause the safety valve to leak. A leaking safety valve must be replaced.
- ⚠ Insufficient service clearance will make repairs more difficult and time-consuming.
- ⚠ Piping sized too small may cause water hammer, resulting in damage to the sterilizer.
- ⚠ After installation, it is mandatory to brace piping at the drain funnel so that it will not move vertically.
- ⚠ Make sure door opening is clear of any obstruction before closing the door(s).
- ⚠ Do not attempt to open sterilizer door during manual operation unless chamber is at 0 psig (0 bar).
- ⚠ Never use a wire brush, abrasives, or steel wool on door and chamber assembly. Do not use cleaners containing chloride on stainless-steel surfaces. Chloride-based cleaners will deteriorate stainless steel, eventually leading to failure of the vessel.
- ⚠ Immediately wipe up saline solution spills on loading car, to prevent damage to stainless steel.
- ⚠ Do not use cleaners containing chlorides on loading cars. Chloride-based cleaners will deteriorate the loading car metal.
- ⚠ Sterilization of chloride-containing solutions (e.g., saline) can cause chamber corrosion and is not recommended by the manufacturer. If, however, chloride-containing solutions must be processed, clean the chamber after each use.
- ⚠ Avoid damage to the integral steam generator daily. Flush the generator daily. Failure to flush generator daily will void the manufacturer's warranty.

## Definition of Symbols

Symbol	Definition
	Transfer of Heat, Hot Surface
	Protective Earth (Ground)
	Electrostatic Sensitive Device
	Attention, Consult Manual for Further Instructions
<b>A</b>	Amperage Rating of the unit
<b>V</b>	Voltage Rating of the unit
~	Alternating Current
<b>Hz</b>	Frequency of the unit
$\phi$	Phase of the unit
<b>SN</b>	Serial Number of Unit

## 2.1 Installation Checklist



**CAUTION - POSSIBLE EQUIPMENT DAMAGE HAZARD: Insufficient service clearance will make repairs more difficult and time-consuming.**

An equipment drawing showing all utility and space requirements was supplied with the sterilizer. Clearance space shown on the drawing is necessary for ease of installation and to help ensure proper operation and maintenance of equipment. Uncrating and Installation Instructions were also furnished with the sterilizer. If any of these documents are missing or misplaced, contact STERIS giving the serial and model numbers of the equipment. Replacement copies will be sent out promptly.

After installing this unit according to the instructions provided, complete the following checklist to help ensure installation is complete and correct. Or, if desired, call STERIS to schedule a technician to test the installation and demonstrate proper equipment operation.

### 2.1.1 Service Clearance

- Clearance as specified on the equipment drawing must be available.

### 2.1.2 Plumbing Services

- **Feed Water:**
  - All supply line shutoffs must be provided with lockout capability.
  - Backflow prevention is not provided by STERIS.
  - Water Pressure—measured (specification is 1.4 to 3.5 bar [20 to 50 psig], dynamic). Water pressure supplied must be within specifications as shown on the equipment drawing. If pressure is too high, a regulator must be installed. If water pressure is too low, equipment performance is affected.
  - Water Quality—supplied must be within specifications. Improper water quality adversely affects equipment operation. Damage to the equipment due to improper water quality is not covered under warranty.
- **Steam Supply:**
  - **Shutoffs** (with provisions for lockout and tagout) located nearby.
  - **Supply piping** adequately sized.
  - **Supply pressure** measured (specification is 3.5 to 5.2 bar [50 to 80 psig], dynamic).
  - **Drain piping** must be sloped properly, and sized to handle the maximum waste flow from the sterilizer.

---

## 2.2 Technical Specifications

---

### 2.2.1 Electrical Service

- Electric single-phase service to the unit must be as specified on the Equipment Drawing and on the Machine Data Plate.
- Electric single-phase service requires a clearly marked disconnect with lockout/tagout capability located near the sterilizer.
- Electric single-phase service should be on a separate circuit, and not tied into circuits containing large reactive loads (e.g., motors).
- The sterilizer's protective ground must be connected to terminal block TB-1 in the sterilizer power box. Use green/yellow wire for European installations.
- 3-phase service requires a clearly marked disconnect with lockout/tagout capability located near the sterilizer.

### 2.2.2 Sterilizer Final Check

- Chamber must be leveled properly.
- Door must open and close smoothly.
- Door locked switches must be adjusted correctly.
- Chamber strainer must be in place.
- Rack and shelves and/or loading car operates correctly.
- Warranty labels properly applied.

### 2.2.3 Cycle Operation

- Unit powers up correctly.
- Run Leak Test cycle—leak rate is to be less than 1.0 mm Hg/minute (1.3 mbar/minute). Only on prevac sterilizers.
- Verify operation of a typical cycle (121° C [250°F] gravity).

### 2.2.4 Overall Size and Weight

- **16 x 16 x 26"** 660 mm wide x 1892 mm high x 902 mm deep  
**Sterilizer:** (26" wide x 74.5" high x 35.5" deep)
- **20 x 20 x 38"** 762 mm wide x 1892 mm high x 1152 mm deep  
**Sterilizer:** (30" wide x 74.5" high x 45.375" deep)

### 2.2.5 Electrical Service

#### • Electric:

Controls: 230 VAC, 1.5A, 1-phase, 50/60 hz  
Vacuum Pump: 120 VAC, 9.5A, 1-phase, 50/60 hz  
440/480 VAC, 31/37A, 3-phase, 50/60 hz  
240 VAC, 72.2A, 3-phase, 50/60 hz

#### • Steam:

Pressure: 50 to 80 psig (344.7 to 551.6 Kpa)  
Consumption:

- 16 x 16 x 26" (406 x 406 x 660 mm) 83 lb/hr (38 kg/hr ) peak
- 20 x 20 x 38" (508 x 508 x 965 mm) 116 lb/hr (53 kg/hr ) peak

#### • Cold Water:

Pressure: 206.8 to 344.7 Kpa (30 to 50 psig)  
Temperature: 70°F (21°C, maximum)  
Consumption: Peak 6gpm, per cycle 140 gal, Idle 10 gph

### 2.2.6 Environmental Conditions

Temperature: 10° to 32°C (50° to 90°F)  
Humidity: 10 to 90% noncondensing  
Pollution Degree: 2  
Installation Category (Overvoltage Category): II  
A-Weighted Sound Power Level: 85 dBA (maximum)

### 2.2.7 Utility Requirements For Units Equipped With Optional Electric Steam Sterilizers

#### • Electric:

Controls: 120 VAC, 2.5A, 1-phase, 50/60 hz  
Generator Heaters: 208 VAC, 83.2A, 3-phase, 50/60 hz  
440/480 VAC, 31/37A, 3-phase, 50/60 hz  
240 VAC, 72.2A, 3-phase, 50/60 hz

#### • Hot Water:

Pressure: 137.9 to 344.7 Kpa (20 to 50 psig)  
Temperature: 140°F, maximum  
Consumption: Peak 1gpm, per cycle 4 gal, Idle 1 gph

#### • Stainless-Steel Option Only:

Distilled, Reverse-Osmosis (RO), or Deionized Water with a minimum specific resistivity of 1 mΩ/cm.

#### • Cold Water:

Pressure: 206.8 to 344.7 Kpa (30 to 50 psig)  
Temperature: 70°F (21°C, maximum)  
Consumption: Peak 6gpm, per cycle 140 gal, Idle 10 gph

### 2.2.8 Environmental Conditions

Temperature: 10° to 32°C (50° to 90°F)  
Humidity: 10 to 90% noncondensing  
Pollution Degree: 2  
Installation Category (Overvoltage Category): II  
A-Weighted Sound Power Level: 85 dBA (maximum)

## 3.1 Recommended Sterilization Variables

### 3.1.1 Prevacuum Cycle

The Prevacuum cycle is recommended to process heat- and moisture-stable goods, except liquids, which are capable of being sterilized with steam. This cycle can also be used to decontaminate wastes, including wastes containing liquids, provided the materials are properly contained.

Refer to **Table 3-1** for recommended Prevacuum cycle parameters.

**Table 3-1. Prevacuum Cycle Parameters**

Temperature	Pressure Point Psig (psia)	Minimum Recommended Sterilize Time* Minutes at Temperature
121°C (250°F)	12-14 (27-29)	15
132°C (270°F)	26-28 (40-42)	4

\* Minimum sterilize times are based on obtaining a 10<sup>6</sup> Sterility Assurance Level (SAL) with standard test loads. Your specific loads may require different sterilize times to achieve this level of sterility, or you may require a different SAL.

### 3.1.2 Gravity Cycle

Refer to **Table 3-2** for the type of items which can be processed in a Gravity cycle and the recommended parameters.

**Table 3-2. Gravity Cycle Parameters**

Items	Minimum Recommended Sterilize Time at 121°C (250°F) (minutes)	Minimum Recommended Sterilize Time at 132°C (270°F) (minutes)	Dry Time (minutes)
<b>Glassware</b> Empty, inverted, vented*	15 Min.	3 Min.	0 Min.**
<b>Instruments</b> metal combined with suture, tubing or other porous materials (unwrapped)	20 Min.	10 Min.	0 Min.**
<b>Hard Goods</b> Unwrapped	15 Min.	3 Min.	0 Min.**

**Table 3-2. Gravity Cycle Parameters (cont.)**

Items	Minimum Recommended Sterilize Time at 121°C (250°F) (minutes)	Minimum Recommended Sterilize Time at 132°C (270°F) (minutes)	Dry Time (minutes)
<b>Hard Goods</b> Wrapped in muslin or equivalent	30 Min.	15 Min.	30 Min.

\* If items which can trap air must be sterilized upright, they should be sterilized in a prevacuum cycle.

\*\* Goods will be wet when removed from sterilizer.

\*\*\* Dry time can vary for wrapped goods depending on pack density, weight of goods, pack preparation techniques including type of wrapping material used, and sterilizer loading procedures.

### 3.1.3 Liquid Cycle

Refer to **Table 3-3** for recommended Liquid cycle parameters. The recommended times indicated in **Table 3-3** assume the use of vented bottles or Erlenmeyer flasks. The *minimum sterilization time* includes the time required to bring the solution up to the sterilization temperature plus the time required to achieve sterilization.

*NOTE: Use load probes and  $F_0$  option to optimize cycle times.*

**Table 3-3. Liquid Cycle Parameters - No Load Probes**

Volume of Liquid in One Container (mL)	Minimum Recommended Sterilize Time* at 121°C (250°F) (minutes)
75	25
250	30
500	40
1000	45
1500	50
2000	55
>2000	55+ 10 min/L

\* Minimum sterilize times are based on obtaining a 10<sup>6</sup> Sterility Assurance Level (SAL) with standard test loads. Specific labs may require different sterilize times to achieve this level of sterility, or may require a different SAL.

---

## 3.2 Control Measures for Verifying Sterilization Process

---

### 3.2.1 Biological Monitors

A live spore test utilizing *B. stearothermophilus* is the most reliable form of biological monitoring. This type of product utilizes controlled populations of a controlled resistance, so that survival time and kill time can be demonstrated.

To verify the process, insert the biological indicator in a test pack and place pack on the bottom shelf. Run test pack through a typical cycle. On completion, forward test pack and monitor to appropriate personnel for evaluation.

Tests such as the Bowie-Dick (using a STERIS Dart® test pack\*) are designed to document the removal of residual air from a sample challenge load.

Run a Bowie-Dick test cycle daily before processing any loads in a sterilizer equipped with prevacuum cycles. The first prevacuum cycle of each day should be used to test the adequacy of air removal from the chamber and load, so that steam can penetrate the load. It is not a test for adequate exposure to heat in terms of time-at-temperature.

### 3.2.2 Testing for Prevacuum Efficiency

In the case of these tests, following exposure in a prevacuum sterilizing cycle, the pack is opened, the indicator examined, and conclusions are drawn as to the pattern of residual air, if any, that remained in the pack during the sterilizing cycle. Any indication of a malfunction must be reported to the supervisor. Sterilizer must not be used again until approved by supervisor.



**WARNING – STERILITY ASSURANCE HAZARD:** Load sterility may be compromised if the biological indicator or vacuum leak test indicates a potential problem. If these indicators show a potential problem, refer the situation to a qualified service technician before using the sterilizer further.

\* Call STERIS for pricing and availability.



---

### 3.3 Bowie-Dick Test

---



**WARNING – STERILITY ASSURANCE HAZARD:** Load sterility may be compromised if the biological indicator or vacuum leak test indicates a potential problem. If these indicators show a potential problem, refer the situation to a qualified service technician before using the sterilizer further.

The Bowie-Dick Test is designed to document the removal of residual air from a sample challenge load in a prevacuum sterilizer. This test does not apply to gravity, liquids, or Isothermal cycles.

In the case of this test, following exposure in a prevacuum test cycle, the pack is opened, the indicator examined and conclusions are drawn as to the pattern of residual air, if any, that remained in the pack during the sterilizing cycle. Any indication of a malfunction must be reported to the supervisor. Sterilizer must not be used to run prevacuum cycles until approved by supervisor.

Refer to instructions for running the Bowie-Dick test cycle in *SECTION 6, STERILIZER OPERATION*. Dart (Bowie-Dick) test packs\* are designed to expose the pattern and document the removal of residual air from the sample load.

*NOTE: The Bowie-Dick test cycle is not a test for adequate exposure to heat in terms of time-at-temperature.*

\* Call STERIS for pricing and availability.

---

### 3.4 Vacuum Leak Test

---



**WARNING – STERILITY ASSURANCE HAZARD:** Load sterility may be compromised if the biological indicator or vacuum leak test indicates a potential problem. If these indicators show a potential problem, refer the situation to a qualified service technician before using the sterilizer further.

The Vacuum Leak Test (see appropriate cycle description in *SECTION 5, CONTROL INTERFACE*) measures the integrity of the sealed pressure vessel and associated piping to verify air is not being admitted to the sterilizer during the vacuum drawdowns.

After running a Leak Test cycle, a value or leak rate prints on the printer tape. This value helps define a trend over a period of time if the integrity of the system begins to deteriorate (i.e., allowing air to enter the system). By running a Leak Test cycle daily or weekly, the operator or maintenance personnel can always monitor the air tightness of the system and make repairs or adjustments when necessary.

*NOTE: A leak rate of greater than 1 mmHg per minute indicates a problem with the sterilizer that must be addressed.*

---

## **3.5 Recommendations for the Sterilization Process**

---

Saturated steam is a well controlled, reliable method for processing items which can withstand the temperatures and pressures associated with steam sterilization. The requirements for achieving reproducible results are well known by many users, but are not always understood by all users.

The condition most likely to result in sterilization problems is a failure to remove all of the air from the items being processed. For example, placing an empty beaker or bowl in an upright position in a gravity displacement sterilizer may result in the object not being sterilized, or may require exceptionally long sterilization times. This problem is due to the fact air has almost twice the density as does saturated steam under the same conditions. Thus, the air sits in the bottom of the container, and the steam forms a stable layer over the air. This effect is similar to oil forming a stable layer over water. As long as there is no mechanism for actively mixing the two, the bottom of the container only is exposed to dry heat only, which is not an effective sterilization method at the time and temperatures typically used in steam processes.

There are two traditional methods for enhancing the sterilization of solid bottom containers in gravity displacement cycles. These are:

- Place 1 mL of water for each liter of volume in the bottom of each container. The expansion of the water into steam, as the product is heated, forces most of the air out of the object, thus allowing steam to reach all surfaces and effect sterilization.
- The better, more reliable method is to orient all objects in a manner which would allow water to flow out. When the steam enters the chamber, it tends to layer over the air. When inverted, however, the object is oriented so air can flow out. As air flows out of the container, it is replaced by steam. Steam can now reach all surfaces, and effect sterilization.

## 3.6 Techniques of Sterilization for Liquid Cycle

**⚠ WARNING–EXPLOSION HAZARD:** This sterilizer is not designed to process flammable compounds.

**⚠ WARNING–PERSONAL INJURY HAZARD:** Avoid personal injury from bursting bottles. Liquid sterilization cycle must only be used for liquids in borosilicate (Pyrex) flasks with vented closures.

**⚠ WARNING:** When sterilizing liquids, you must observe the following procedures:

- Use Liquid cycle only.
- Use only vented closures.
- Use only Type I borosilicate glass bottles.
- Do not allow hot bottles to be jolted.

**⚠ WARNING–BURN HAZARD:** Steam may be released from the chamber when door is opened. Step back from the sterilizer each time the door is opened to minimize contact with steam vapor.

**⚠ CAUTION:** Sterilization of chloride-containing solutions (e.g., saline) can cause chamber corrosion and is not recommended by the manufacturer. If, however, chloride-containing solutions must be processed, clean the chamber after each use.

Refer to **Table 3-4** for suggested Liquid cycle parameters. The suggested times indicated in **Table 3-4** assume the use of vented bottles. The *minimum sterilization time* includes the time required to bring the solution up to the sterilize temperature plus the time required to achieve sterilization. This time may vary due to viscosity of liquid and other parameters.

**Table 3-4. Liquid Cycle Parameters**

Number of Containers	Volume of Liquid in One Container	Minimum Recommended Sterilize Time at 250°F (121°C) in Minutes
3	1000 mL	45

## 3.7 Recommendations for Sterilizing Liquids

**⚠ WARNING – EXPLOSION HAZARD:** This sterilizer is not designed to process flammable compounds.

**⚠ WARNING – PERSONAL INJURY HAZARD:** Avoid personal injury from bursting bottles. Liquid sterilization cycle must only be used for liquids in borosilicate flasks with vented closures.

**⚠ WARNING – BURN HAZARD:** When sterilizing liquids, *always* observe the following procedures:

- Use Liquid cycle only.
- Use only vented closures.
- Use only Type I borosilicate glass bottles.
- Do not allow hot bottles to be jolted.
- **WARNING–BURN HAZARD:** Steam may be released from the chamber when door is opened. Step back from the sterilizer each time the door is opened to minimize contact with steam vapor.

**⚠ CAUTION:** Sterilization of chloride-containing solutions (e.g., saline) can cause chamber corrosion and is not recommended by the manufacturer. If, however, chloride-containing solutions must be processed, clean the chamber after each use.

**IMPORTANT:** Please read the following paragraphs before sterilizing any liquids in the sterilizer.

Borosilicate glass is required because it is a superior glass capable of resisting thermal shock. If glass not as thermally resistant is used, a greater potential for bursting exists.

Vented closures are required because, by design, they release internal pressure build-up by automatically venting the containers, whereas pressure in unvented containers remains until the contents have cooled. Examples of vented closures are shown in Figure 3-1.

When loading, place small bottles in a separate basket to minimize sliding. Always use side rails on the loading car to prevent containers or baskets from falling off.

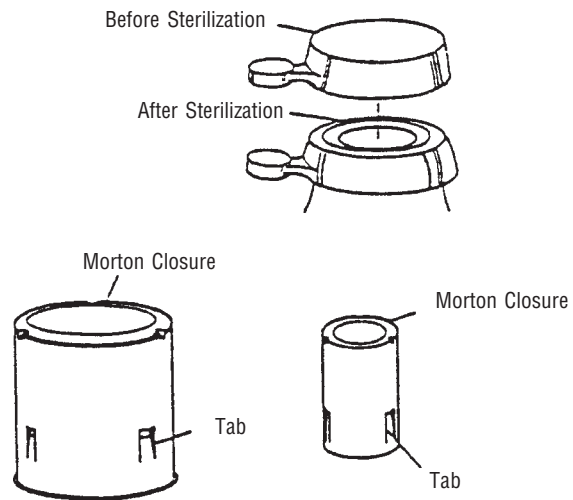

Figure 3-1. Vented Closures

## 4.1 Component Identification

The Lab 250 and Lab 110 Life Sciences Small Steam Sterilizers are steam-jacketed sterilizers designed to process a variety of loads using saturated steam under pressure and gravity air removal principals.

The Sterilizer is equipped with a fully-programmable microcomputer control system capable of storing process cycles for sterilizing hard goods, lightly wrapped porous loads and liquid loads in vented containers. The control system monitors and automatically controls all cycle operations and functions.

Before operating the sterilizer, it is important to become familiar with the location and function of all major components and controls (see Figure 4-1).



**Figure 4-1. Lab 250 Series Sterilizer**

### 4.1.1 Main Power Disconnect Switch

The main power disconnect switch, located behind the front cabinet panel, controls power supply to the sterilizer and control system (see Figure 4-2).

**Important:** This switch should remain in the ON position at all times for normal unit operation.



**WARNING-ELECTRIC SHOCK AND BURN HAZARD:** Disconnect all utilities to sterilizer before servicing. Do not service the sterilizer unless all utilities have been properly locked out. Always follow appropriate Lockout-Tagout and electrical safety-related work practice standards.

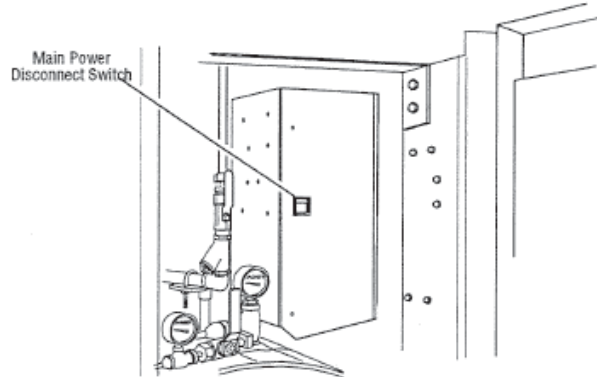

**Figure 4-2. Main Power Disconnect Switch**

### 4.1.2 Supply Valves

Supply valves to the sterilizer are located behind the front cabinet panel. Steam supply valve is located above the chamber door (see Figure 4-3); water supply valve is located below the chamber door (see Figure 4-3).

**NOTE:** If unit is equipped with electric steam generator, refer to SECTION 4.5-OPTIONAL ELECTRIC STEAM GENERATOR, included in this section, for location of the generator supply valve.

**Important:** Both supply valves to the sterilizer should remain in the ON position at all times for normal unit operation.

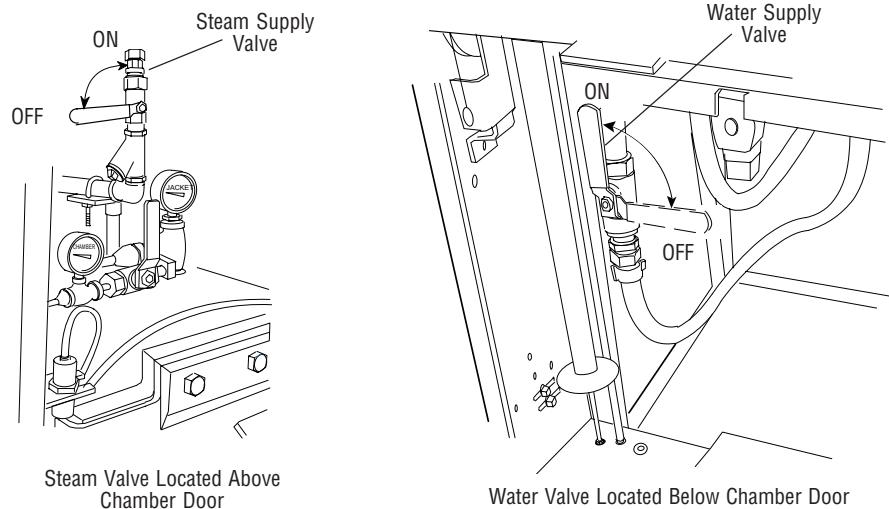

**Figure 4-3. Steam and Water Supply Valves to the Sterilizer**

---

## 4.2 Control Panel

---

### 4.2.1 Touch Screen

The control panel, located on load end of the sterilizer, is used to direct all sterilizer functions (see Figure 4-4). The operator may control cycle operation, program cycles and sterilizer operating parameters and monitor cycle performance from the control panel.

The touch screen allows the user to operate and program the sterilizer control by touching (pressing) the appropriate touch-sensitive areas on the display. On each screen, all rectangular-outlined boxes are touch-sensitive areas, referred to as **buttons** (see Figure 4-4).

Refer to *SECTION 5, CONTROL INTERFACE*, for further details on interfacing with the control system's touch screen.



**Figure 4-4. Example of In-cycle Touch Screen**

### 4.2.2 Printer (Optional)

Ink-on-paper printer records all cycle data on 2-1/4" wide paper.

The following is an example of a typical in-cycle printout in the condensed print format (see Figure 4-5).

```

=====
===== GRAVITY =====
=====
CYCLE START AT      XX:XX:XX A/P
                   ON      XX/XX/XX

CYCLE COUNT         0
LOGIN NAME:         XXXXXX
STERILIZER          XXXXXX

CYCLE TYPE          GRAVITY
CYCLE NO.           2

STER TEMP = 121.0 C
CONTROL TEMP = 122.5 C
STER TIME = 0:30:00
DRY TIME = 0:01:00

- TIME              T=C          V=inHg
                   P=psig
-----
C 11:48:24A        66.7          0.3V
C 11:49:24A        112.7         10.0P
S 11:49:43A        121.2         16.6P
S 11:51:43A        122.6         17.7P
S 11:53:43A        123.3         17.8P
S 11:55:43A        123.6         16.8P
S 11:57:43A        122.6         17.0P
S 11:59:43A        122.6         17.2P
S 12:01:43P        122.5         17.0P
S 12:03:43P        122.4         17.2P
S 12:05:43P        122.5         16.8P
S 12:07:43P        122.4         16.9P
S 12:11:43P        122.4         17.0P
S 12:13:43P        122.5         17.1P
S 12:15:43P        122.6         17.0P
S 12:17:43P        122.7         17.0P
S 12:19:43P        122.6         16.8P
E 12:19:44P        122.6         16.9P
E 12:19:54P        113.7          3.2P
E 12:20:03P        99.9          11.1V
E 12:21:03P        40.5          28.1V
Z 12:21:46P        68.4           0.5V

LOAD                020903

CHAMBER TEMP MAX=124.8 C
CHAMBER TEMP MIN=121.2 C

CONDITON           = 1:19
STERILIZE           = 30:01
EXHAUST             = 1:42
TOTAL CYCLE         = 33:02

=====
===== READY TO UNLOAD =====
=====

```

**Figure 4-5. Condensed Printout**

All printer functions are controlled using the touch screen. For details on each of the printer functions, refer to *SECTION 5, CONTROL INTERFACE*.

*NOTE: Extended print format is available.*



### 4.2.3 Operating Mode

When sterilizer is placed in the Operating mode, the generated printout lists the sterilizer type and manufacturer.

```
CONTROL ON
Day, Month XX, XXXX
XX:XX:XX AM
*****
*   STERIS SCIENTIFIC   *
*   LAB 110 / 250 SERIES *
*   GRAVITY STERILIZER  *
*   MADE IN U.S.A.      *
*****
*****
```

**Figure 4-6. Printout: Sterilizer Type and Manufacturer**

### 4.2.4 Cycle Start

When a cycle is started, the generated printout lists name of cycle started, time and date the cycle was started, the current cycle count (number of cycles run since original start up of unit), the operator's name, the sterilizer ID number, the default cycle number and type, and the programmed parameters for the cycle started.

*NOTE: Cycle count value may be changed in the Supervisor Mode.*

### 4.2.5 End-of-Cycle Performance Summary

At the end of a cycle, the generated printout lists number of cycles run that day, the maximum and minimum chamber temperatures reached during the sterilize phase, processing times for key phases and the total cycle time.

### 4.2.6 Alarm Condition

When an alarm condition occurs, the generated printout (see Figure 4-6) lists the type of alarm and time, chamber temperature and chamber pressure when it occurred.

*NOTE: Refer to SECTION 7, ALARMS, for listing of possible alarm conditions.*

```
* ALARM
PRESSURE IN CHAMBER
F 10:07:23A    61.7C    34.0P
```

**Figure 4-7. Printout: Type of Alarm, Chamber Temperature and Chamber Pressure, and Time of Occurrence**

---

## 4.3 Manual Operation of Manual Door

---

Carefully review *SECTION 1, SAFETY PRECAUTIONS*, and below before operating door manually.

 **WARNING - PERSONAL INJURY HAZARD:** When closing the chamber door, keep hands and arms out of the door opening and make sure opening is clear of obstructions.

 **WARNING - BURN HAZARD:**

- Steam may be released from the chamber when door is opened. Step back from the sterilizer each time the door is opened to minimize contact with steam vapor.
- Do not attempt to open the sterilizer door if a **WATER IN CHAMBER ALARM** condition exists. Call a qualified service technician before attempting to use sterilizer further.
- After manual exhaust, steam may remain inside the chamber. Always wear protective gloves, apron, and a face shield when following emergency procedure to unload sterilizer. Stay as far back from the chamber opening as possible when opening the door.

 **CAUTION - POSSIBLE EQUIPMENT DAMAGE HAZARD:**

- Gasket must be fully retracted prior to operating sterilizer door.
- Make sure door opening is clear of any obstruction before closing the door(s).
- Do not attempt to open sterilizer door during manual operation unless chamber is at 0 psig (0 bar).
- Do not try to raise or lower door rapidly as fast operation may damage the manual door mechanism.

Using hand pressure, pull up or push down on the door handle to operate the door.

*NOTE: Do not try to raise or lower door rapidly as fast operation may damage the door drive mechanism.*

---

## 4.4 Emergency Door Operation

---

Carefully review *SECTION 1, SAFETY PRECAUTIONS*, and below before operating emergency door. (Refer to page 4-8 for procedure.)



### WARNING - BURN HAZARD:

- Do not attempt to open the sterilizer door if a **WATER IN CHAMBER ALARM** condition exists. Call a qualified service technician before attempting to use sterilizer further.
- After manual exhaust, steam may remain inside the chamber. Always wear protective gloves, apron, and a face shield when following emergency procedure to unload sterilizer. Stay as far back from the chamber opening as possible when opening the door.
- Allow sterilizer to cool to room temperature before performing any cleaning or maintenance procedures.
- Do not attempt to open the sterilizer door if a **WATER IN CHAMBER ALARM** condition exists. Call a qualified service technician before attempting to use sterilizer further.
- Failure to shut off the steam supply when cleaning or replacing strainers can result in serious injury.
- Jacket pressure must be 0 psig (0 bar) before beginning work on the steam trap.
- Proper testing of the safety valve requires the valve to be operated under pressure. Exhaust from the safety valve is hot and can cause burns. Proper safety attire (gloves, eye protection, insulated overall) is required. Testing is to be performed by qualified service personnel only.
- When sterilizing liquids, to prevent personal injury or property damage resulting from bursting bottles and hot fluid, you must observe the following procedures:
  - Use **LIQUID** cycle only; no other cycle is safe for processing liquids.
  - Use only vented closures; do not use screw caps or rubber stoppers with crimped seal.
  - Use only Type 1 borosilicate glass bottles; do not use ordinary glass bottles or any container not designed for sterilization.
  - Do not allow hot bottles to be jolted; this can cause hot-bottle explosions. Do not move bottles if any boiling or bubbling is present.



**WARNING - EXPLOSION HAZARD:** This sterilizer is not designed to process flammable compounds.



**WARNING - PERSONAL INJURY AND/OR EQUIPMENT DAMAGE HAZARD:** Repairs and adjustments to this equipment must be made only by fully qualified service personnel. Maintenance performed by inexperienced, unqualified persons or installation of unauthorized parts could cause personal injury or result in costly equipment damage.



### CAUTION - POSSIBLE EQUIPMENT DAMAGE HAZARD:

- Gasket must be fully retracted prior to operating sterilizer door.
- Do not attempt to open sterilizer door during manual operation unless chamber is at 0 psig (0 bar).

The following emergency procedure should only be used in instances where the sterilizer has lost either electrical or water utilities, and a load is sealed in the chamber. This procedure requires manually releasing the door seal by pressing on the door and pushing the seal back into the groove.

1. Open front cabinet panel. Open manual exhaust valve to exhaust remaining steam from the chamber (see Figure 4-8). Leave valve open during emergency procedure.
2. Using pressure tool provided, press on upper left hand and right hand corners of chamber door as shown in figure 4-8. Door should give inward slightly, indicating seal has been compressed into groove.
3. Close front cabinet panel and pull down on door handle.
4. Once door is open, do not use sterilizer until unit has been examined by a qualified service technician. Further use without proper attention may damage sterilizer.
5. Close manual exhaust valve.

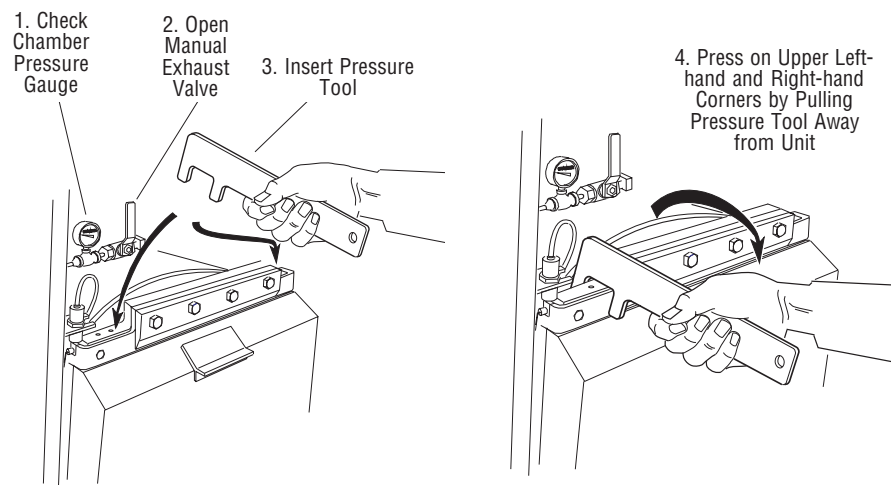

**Figure 4-8. Emergency Door Operation**

## 4.5 Optional Electric Steam Generator

Carefully review *SECTION 1, SAFETY PRECAUTIONS* and below before operating steam generator. If a building steam source is not available, the sterilizer may be equipped with an electric steam generator. The generator automatically converts water to steam using electric heat. The steam created is then used to power the sterilizer.



### WARNING - BURN HAZARD:

- Do not attempt to open the sterilizer door if a **WATER IN CHAMBER ALARM** condition exists. Call a qualified service technician before attempting to use sterilizer further.
- After manual exhaust, steam may remain inside the chamber. Always wear protective gloves, apron, and a face shield when following emergency procedure to unload sterilizer. Stay as far back from the chamber opening as possible when opening the door.
- Allow sterilizer to cool to room temperature before performing any cleaning or maintenance procedures.
- Do not attempt to open the sterilizer door if a **WATER IN CHAMBER ALARM** condition exists. Call a qualified service technician before attempting to use sterilizer further.
- Failure to shut off the steam supply when cleaning or replacing strainers can result in serious injury.
- Jacket pressure must be 0 psig (0 bar) before beginning work on the steam trap.
- Proper testing of the safety valve requires the valve to be operated under pressure. Exhaust from the safety valve is hot and can cause burns. Proper safety attire (gloves, eye protection, insulated overall) is required. Testing is to be performed by qualified service personnel only.
- When sterilizing liquids, to prevent personal injury or property damage resulting from bursting bottles and hot fluid, you must observe the following procedures:
  - Use **LIQUID** cycle only; no other cycle is safe for processing liquids.
  - Use only vented closures; do not use screw caps or rubber stoppers with crimped seal.
  - Use only Type 1 borosilicate glass bottles; do not use ordinary glass bottles or any container not designed for sterilization.
  - Do not allow hot bottles to be jolted; this can cause hot-bottle explosions. Do not move bottles if any boiling or bubbling is present.



**WARNING - EXPLOSION HAZARD:** This sterilizer is not designed to process flammable compounds.



**WARNING - PERSONAL INJURY AND/OR EQUIPMENT DAMAGE HAZARD:** Repairs and adjustments to this equipment must be made only by fully qualified service personnel. Maintenance performed by inexperienced, unqualified persons or installation of unauthorized parts could cause personal injury or result in costly equipment damage.



### CAUTION - POSSIBLE EQUIPMENT DAMAGE HAZARD:

- Gasket must be fully retracted prior to operating sterilizer door.
- Do not attempt to open sterilizer door during manual operation unless chamber is at 0 psig (0 bar).

Steam generators are highly susceptible to mineral scaling if the supplied water has any level of hardness. Refer to **Table 4-1** for water quality requirements.

**IMPORTANT:** Regardless of the hardness level of supplied water, the generator must be flushed every day before use to prevent mineral scaling or carryover of debris into the chamber.

**Table 4-1. Required Feed Water Quality for Carbon Steel Steam Generators**

Condition	Nominal Recommended	Maximum Recommended
Temperature	As Supplied	140° F (60° C)
Total Hardness as CaCO <sub>3</sub> *	0-17 mg/L	130 mg/L
Total Dissolved Solids	50-150 mg/L	250 mg/L
Total Alkalinity as CaCO <sub>3</sub>	50-100 mg/L	180 mg/L
pH	6.8 - 7.5	6.5 - 8.5
Total Silica	0.1 - 1.0 mg/L	2.5 mg/L
Resistivity - ohms/cm	2000-6000	26,000

\*17.1 mg/L = 1 grain hardness

1. After the operating mode is entered, see **CONTROL INTERFACE** section for instructions on entering the operating mode, the display shows the following screen (the screen is shown only one time per day):

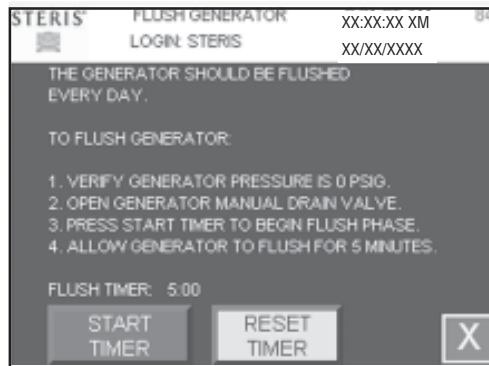

**Screen #84**

2. Check generator pressure gauge (see Figure 4-9). Generator must be at 0 psig and room temperature before flushing.

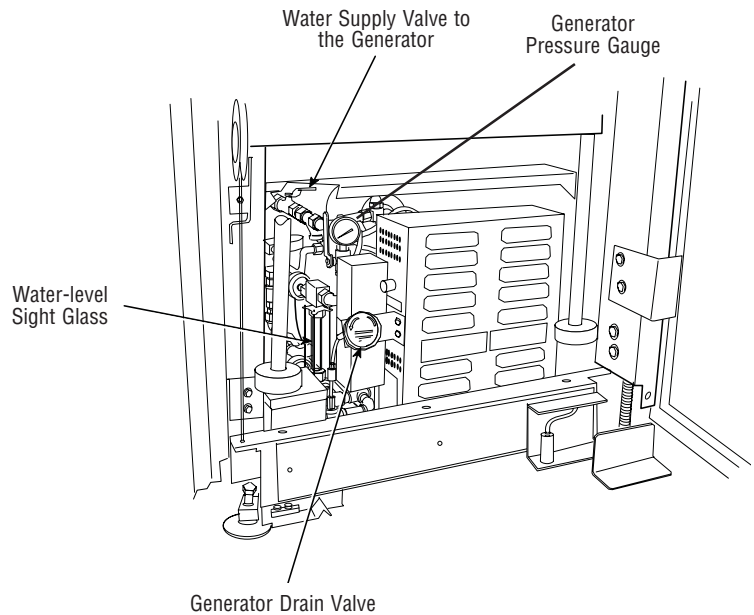
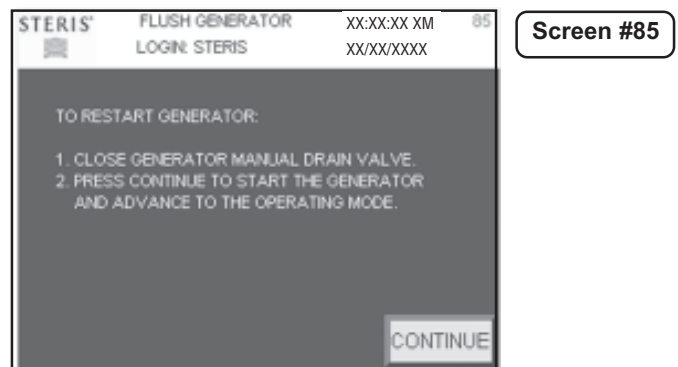

**Figure 4-9. Optional Electric Steam Generator**

*NOTE: If generator is not at 0 psig, the flush phase can be bypassed by pressing **CANCEL**; however, the flush should not be bypassed on a continuous basis or damage to the generator occurs.*

To verify generator is at 0 psig, the sterilizer can be shut off at end of the day and by next morning the unit is able to be flushed. Approximately seven hours is required for generator to cool down to less than 140°F (60°C).

3. Open drain valve on side of generator electric box (see Figure 4-9).
4. Verify water supply valve to sterilizer is open.
5. Verify water supply to generator is open (see Figure 4-9).
6. Press START TIMER button on screen. Water automatically flushes through generator and out the drain for five minutes. Flush timer on screen counts down time remaining in flush phase.
7. After five minutes, display advances to the following screen. Instructions on how to start generator are also listed on the screen.



8. Close generator drain valve.
9. Press **CONTINUE** button on screen. Generator automatically fills to proper level and starts to heat. Display screen advances to operating mode screen. Allow 10 minutes warm-up time once generator starts to fill.
10. Close front cabinet panel.



## 5.1 General Description

Touch screens allow the user to operate and program the sterilizer by lightly touching (pressing) the appropriate touch-sensitive areas on the display. On each screen, all rectangular-outlined boxes are touch sensitive areas, referred to as buttons. When a button is pressed, the display area within the button lights up.

Each screen is identified by a number, located in the top right hand corner of the display screen. Numbers are used for reference only and do not relate to the operating sequence of the screens.

After the sterilizer has been powered up, the display shows the following screen:



Touch any portion of screen to proceed (*Note: Pressing the upper right on the screen will enable the control panel*). Display shows the following screen (*Note: See Password entry*):

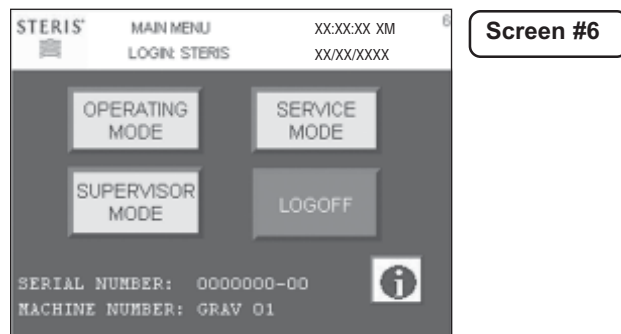

### 5.1.1 Information and Help

Press **INFO** button from screen #6 to display program part numbers and help information. Display shows the following screen:

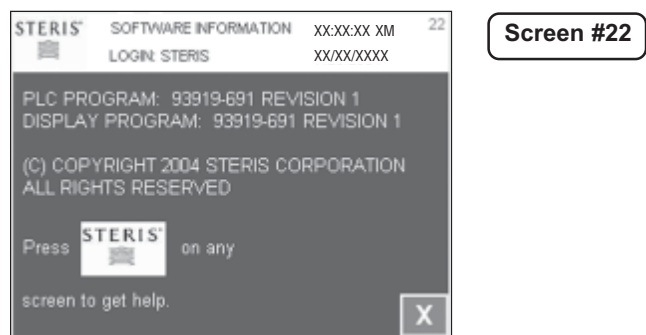

Press **STERIS** button from any screen to get help. An example screen is shown below:

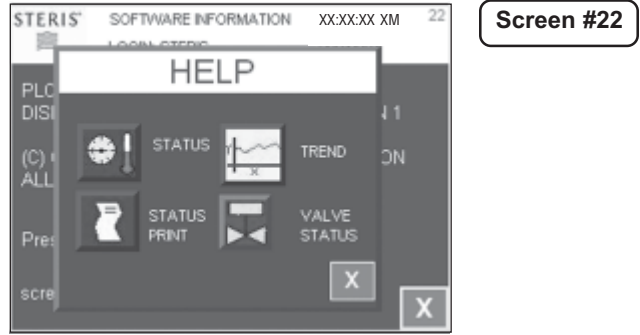

Press **EXIT** button to return to previous display (screen #22). Press **EXIT** button again to return to previous display (screen #6).

### 5.1.2 Password Entry

Press **STERIS** screen to access sterilizer. Display shows the following screen:

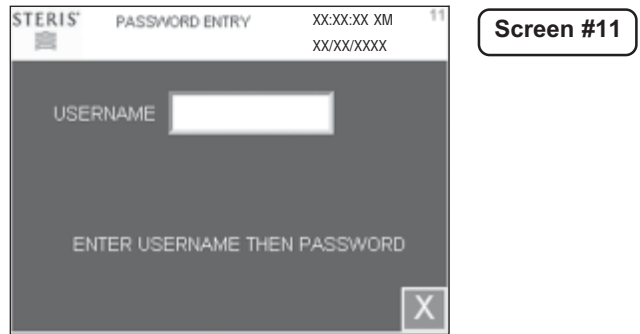

Touch white area next to Username to enter username. An alpha-numeric touch screen is shown. Enter username and press **RETURN** button. The following display is shown:

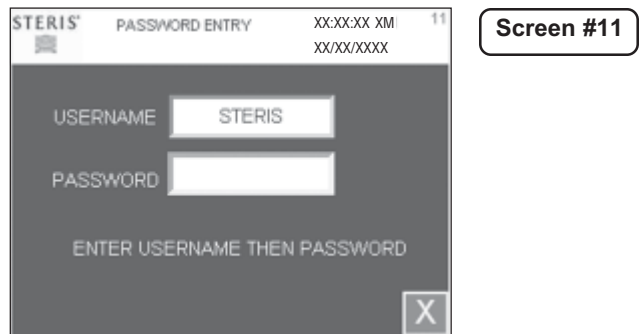

Touch white area next to Password to enter password. An alpha-numeric touch screen is shown. Enter password and press button. If username and/or password are invalid the following message is shown on Screen 11: **INCORRECT PASSWORD**. Re-enter username and password or press **X** button to return to start up screen.

After the username and password have been successfully entered, every screen during the operating mode will show the username (login name).

*Note: The default username is STERIS and the password is 1000. This username and password gains entry to the operating, supervisor, and service modes. Once logged in, this username and password may be changed by the supervisor.*

The operating mode display appears.

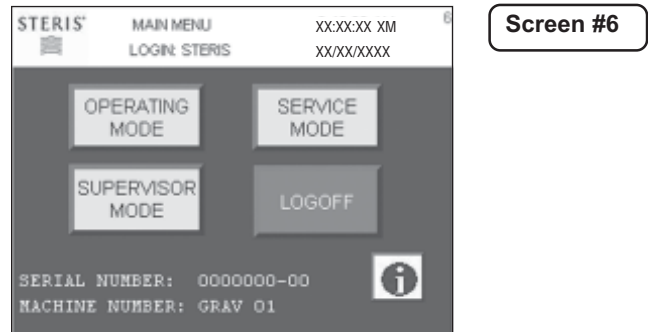

Screen #6 shows the machines serial number, machine number, login name, time and date.

*NOTE: Press upper corner on the 6 to access the system access screen. This screen may be used to set the time, date, time format, date format, etc. Press **RESET TERMINAL** to restart the program.*

## 5.2 Operating Modes

### 5.2.1 Gravity Sterilizer Only

Press **OPERATING MODE** button to enter operating mode. The operating mode display is shown below:

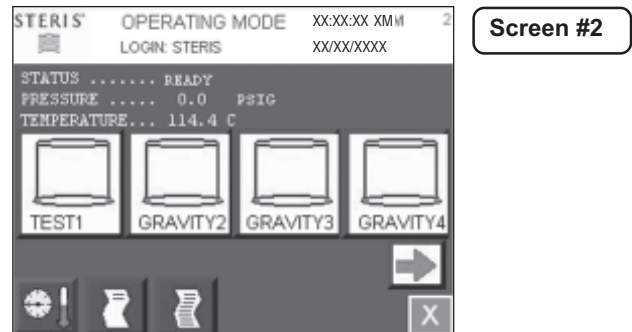

Press **RIGHT ARROW** to advance to the following screen (additional cycles 5 through 8).

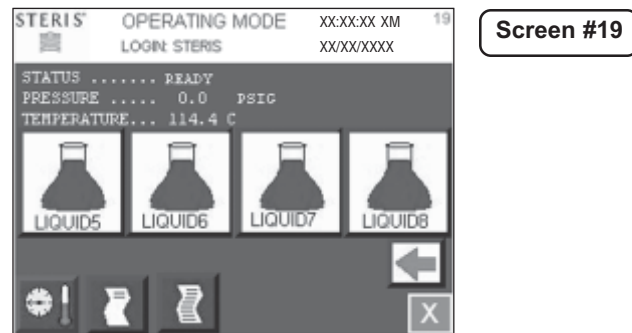

Press **LEFT ARROW** to return to screen #2 (cycles 1 through 4).

The jacket charges with steam to maintain 115.0°C (239.0°F). STATUS on the display shows **DOOR OPEN**, **READY**, or **JACKET CHARGE** depending upon status of the sterilizer. A cycle cannot be run with door open. The cycle may be run with the jacket still charging.

Press **CYCLE** button to select a cycle. The following display is shown for cycles 1 through 8. Corresponding cycle values appear on display.

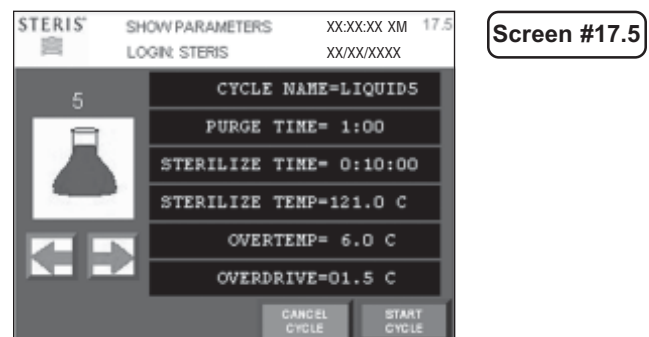

Press **RIGHT ARROW** button to show more cycle parameters. The following display appears:

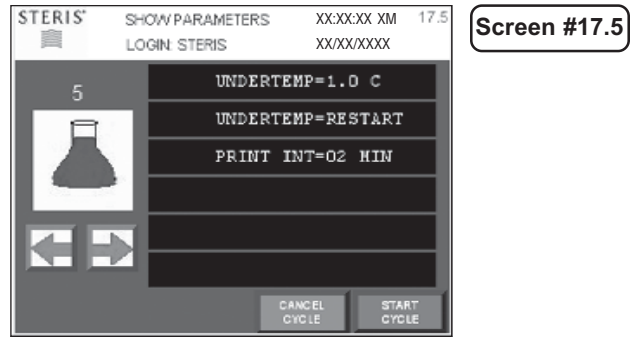

Press **LEFT ARROW** to show the previous values. Press **CANCEL CYCLE** to return to the operating mode screen (2 or 19). Press **START CYCLE** button to start cycle.

*NOTE: If display shows **CLOSE DOOR(S)** message, close the door. The cycle does not start until door is closed.*

Press **PRINT CYCLE VALUES** button to print all cycle values. The following is a print example of all cycles values. (NOTE: STRL, CTRL, and Fo only appear if load probes are selected):

```

=====
==== CYCLE VALUES PRINTOUT ====
=====
XX:XX:XX XM          XX/XX/
XX

LOGIN NAME:  STERIS

1.GRAVITY1
PURGE TIME= 2:00
STER TIME = 0:30:00
STER TEMP = 121.0 C
  OVERTEMP = 6.0 C
OVERDRIVE = 1.5 C
UNDERTEMP = 1.0 C  RESUME
PRINT INT = 2 MIN
  VAC DRY = 10.0 inHg
  DRY TIME = 0:15:00
STRL CTRL = DRAIN
  Fo = 0
-----
2.GRAVITY2
PURGE TIME= 2:00
STER TIME = 0:30:00
STER TEMP = 121.0 C
  OVERTEMP = 6.0 C
OVERDRIVE = 1.5 C
UNDERTEMP = 1.0 C  RESUME
PRINT INT = 2 MIN
  VAC DRY = 10.0 inHg
  DRY TIME = 0:15:00
STRL CTRL = DRAIN
  Fo = 0
-----
3.GRAVITY3
PURGE TIME= 2:00
STER TIME = 0:30:00
STER TEMP = 121.0 C
  OVERTEMP = 6.0 C
OVERDRIVE = 1.5 C
UNDERTEMP = 1.0 C  RESUME
PRINT INT = 2 MIN
  VAC DRY = 10.0 inHg
  DRY TIME = 0:15:00
STRL CTRL = DRAIN
  Fo = 0
-----
4.GRAVITY4
PURGE TIME= 2:00
STER TIME = 0:30:00
STER TEMP = 121.0 C
  OVERTEMP = 6.0 C
OVERDRIVE = 1.5 C
UNDERTEMP = 1.0 C  RESUME
PRINT INT = 2 MIN

```

```

VAC DRY = 10.0 inHg
DRY TIME = 0:15:00
STRL CTRL = DRAIN
  Fo = 0
-----
5.LIQUID5
PURGE TIME= 2:00
STER TIME = 0:30:00
STER TEMP = 121.0 C
  OVERTEMP = 6.0 C
OVERDRIVE = 1.5 C
UNDERTEMP = 1.0 C  RESUME
PRINT INT = 2 MIN
STRL CTRL = DRAIN
  Fo = 0
-----
6.LIQUID6
PURGE TIME= 2:00
STER TIME = 0:30:00
STER TEMP = 121.0 C
  OVERTEMP = 6.0 C
OVERDRIVE = 1.5 C
UNDERTEMP = 1.0 C  RESUME
PRINT INT = 2 MIN
STRL CTRL = DRAIN
  Fo = 0
-----
7.LIQUID7
PURGE TIME= 2:00
STER TIME = 0:45:00
STER TEMP = 121.0 C
  OVERTEMP = 6.0 C
OVERDRIVE = 1.5 C
UNDERTEMP = 1.0 C  RESUME
PRINT INT = 2 MIN
STRL CTRL = DRAIN
  Fo = 0
-----
8.LIQUID8
PURGE TIME= 2:00
STER TIME = 0:45:00
STER TEMP = 121.0 C
  OVERTEMP = 6.0 C
OVERDRIVE = 1.5 C
UNDERTEMP = 1.0 C  RESUME
PRINT INT = 2 MIN
STRL CTRL = DRAIN
  Fo = 0
-----

```

### 5.2.2 Prevac Sterilizer Only (Optional)

Press **OPERATING MODE** button to enter operating mode. The operating mode display is shown below:

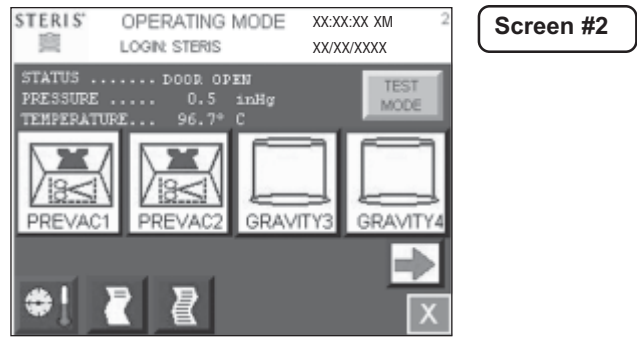

Press **RIGHT ARROW** to advance to the following screen (additional cycles 5 through 8).

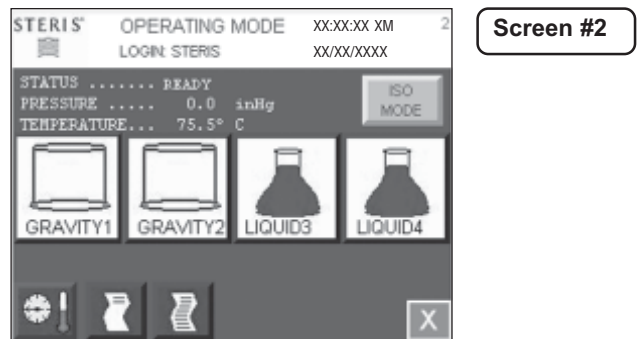

Press **LEFT ARROW** to return to screen #2 (cycles 1 through 4).

Press **TEST MODE** button to show test cycles (LEAK TEST, BOWIE-DICK WARMUP, and BOWIE-DICK).

The following display is shown:

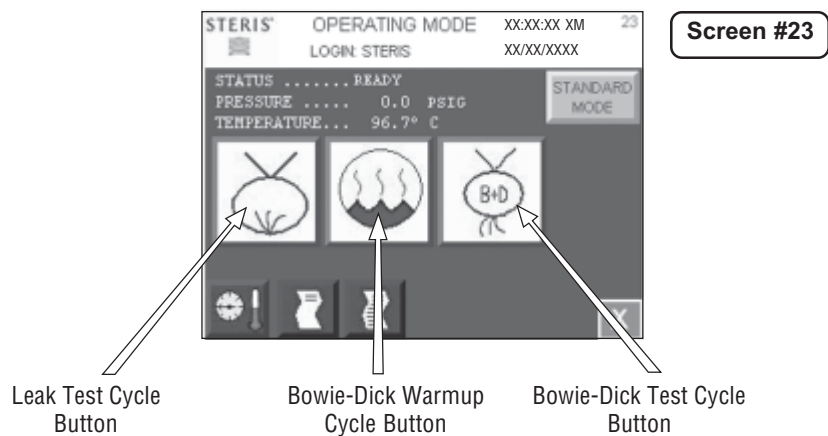

Press **STANDARD MODE** button to return to standard cycles (PREVAC, GRAVITY, and LIQUID).

The jacket charges with steam to maintain 115.0° C (239.0° F). STATUS on the display shows **DOOR OPEN, READY,** or **JACKET CHARGE** depending upon status of the sterilizer. A cycle cannot be run with door open. The cycle may be run with the jacket still charging.

Press **CYCLE** button to select a cycle. The following display is shown for cycles 1 through 8. Corresponding cycle values appear on display.

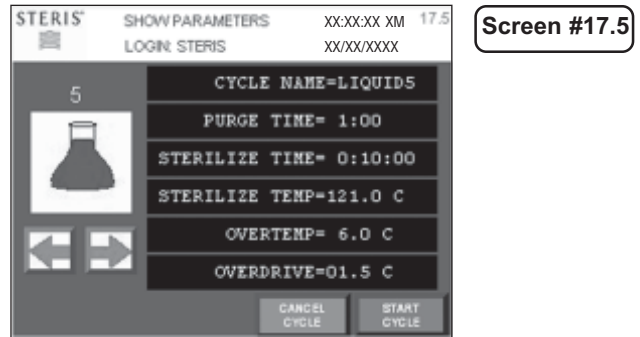

Press **RIGHT ARROW** button to show more cycle parameters. The following display appears:

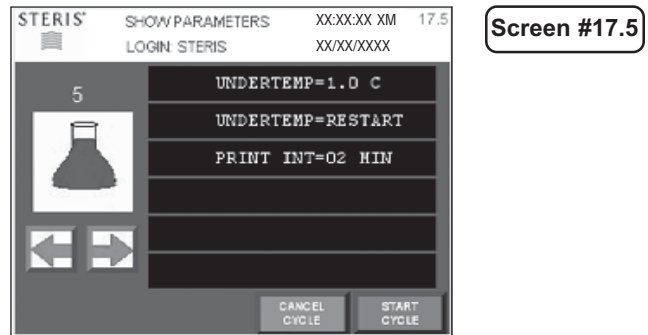

Press **LEFT ARROW** to show the previous values. Press **CANCEL CYCLE** to return to the operating mode screen (2 or 19). Press **START CYCLE** button to start cycle.

**NOTE:** If display shows **CLOSE DOOR(S)** message, close the door. The cycle does not start until door is closed.



Press **PRINT CYCLE VALUES** button to print all cycle values. The following is a print example of all cycles values. (NOTE: STRL, CTRL, and Fo only appear if load probes are selected):

```

=====
==== CYCLE VALUES PRINTOUT ====
=====
XX:XX:XX XM                XX/XX/XX

LOGIN NAME:  STERIS

1. PREVAC1
PURGE TIME= 2:00
  PULSES = 4
  PRES VAC = 10.0 inHg
  PRES CHG = 15.0 PSIG
  STER TIME = 0:30:00
  STER TEMP = 121.0 C
  OVERTEMP = 6.0 C
  OVERDRIVE = 1.5 C
  UNDERTEMP = 1.0 C RESUME
  PRINT INT = 2 MIN
  VAC DRY = 10.0 inHg
  DRY TIME = 0:15:00
  STRL CTRL = DRAIN
  Fo = 0
-----

2. PREVAC2
PURGE TIME= 2:00
  PULSES = 4
  PRES VAC = 10.0 inHg
  PRES CHG = 15.0 PSIG
  STER TIME = 0:30:00
  STER TEMP = 121.0 C
  OVERTEMP = 6.0 C
  OVERDRIVE = 1.5 C
  UNDERTEMP = 1.0 C RESUME
  PRINT INT = 2 MIN
  VAC DRY = 10.0 inHg
  DRY TIME = 0:15:00
  STRL CTRL = DRAIN
  Fo = 0
-----

3. PREVAC3
PURGE TIME= 2:00
  PULSES = 4
  PRES VAC = 10.0 inHg
  PRES CHG = 15.0 PSIG
  STER TIME = 0:30:00
  STER TEMP = 121.0 C
  OVERTEMP = 6.0 C
  OVERDRIVE = 1.5 C
  UNDERTEMP = 1.0 C RESUME
  PRINT INT = 2 MIN
  VAC DRY = 10.0 inHg
  DRY TIME = 0:15:00
  STRL CTRL = DRAIN
  Fo = 0
-----

4. PREVAC4
PURGE TIME= 2:00
  PULSES = 4
  PRES VAC = 10.0 inHg
  PRES CHG = 15.0 PSIG
  STER TIME = 0:30:00
  STER TEMP = 121.0 C
  OVERTEMP = 6.0 C
  OVERDRIVE = 1.5 C
  UNDERTEMP = 1.0 C RESUME
  PRINT INT = 2 MIN

```

```

  VAC DRY = 10.0 inHg
  DRY TIME = 0:15:00
  STRL CTRL = DRAIN
  Fo = 0
-----

5. GRAVITY5
PURGE TIME= 2:00
  STER TIME = 0:30:00
  STER TEMP = 121.0 C
  OVERTEMP = 6.0 C
  OVERDRIVE = 1.5 C
  UNDERTEMP = 1.0 C RESUME
  PRINT INT = 2 MIN
  VAC DRY = 10.0 inHg
  DRY TIME = 0:15:00
  STRL CTRL = DRAIN
  Fo = 0
-----

6. GRAVITY6
PURGE TIME= 2:00
  STER TIME = 0:30:00
  STER TEMP = 121.0 C
  OVERTEMP = 6.0 C
  OVERDRIVE = 1.5 C
  UNDERTEMP = 1.0 C RESUME
  PRINT INT = 2 MIN
  VAC DRY = 10.0 inHg
  DRY TIME = 0:15:00
  STRL CTRL = DRAIN
  Fo = 0
-----

7. LIQUID7
PURGE TIME= 2:00
  STER TIME = 0:45:00
  STER TEMP = 121.0 C
  OVERTEMP = 6.0 C
  OVERDRIVE = 1.5 C
  UNDERTEMP = 1.0 C RESUME
  PRINT INT = 2 MIN
  STRL CTRL = DRAIN
  Fo = 0
-----

8. LIQUID8
PURGE TIME= 2:00
  STER TIME = 0:45:00
  STER TEMP = 121.0 C
  OVERTEMP = 6.0 C
  OVERDRIVE = 1.5 C
  UNDERTEMP = 1.0 C RESUME
  PRINT INT = 2 MIN
  STRL CTRL = DRAIN
  Fo = 0
-----

```

### 5.2.3 Isothermal Sterilizer Only (Optional)

Press **OPERATING MODE** button to enter operating mode. The operating mode display is shown below:

Screen #19

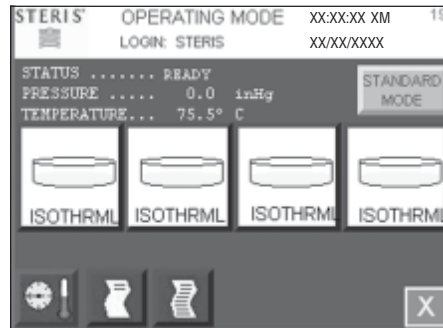

Press **ISO MODE** to enter isothermal mode. The jacket steam is off.

*NOTE: If the jacket temperature is greater than 80.0° C (176.0° F), jacket drains for five minutes.*

Screen #95

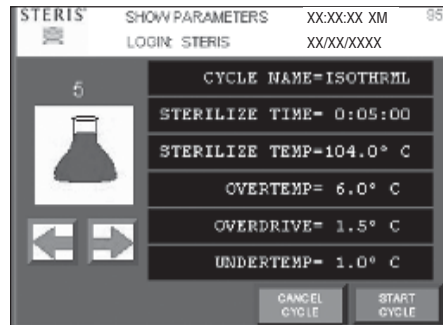

Press **STANDARD MODE** button to return to standard mode (gravity and liquid cycles).

The jacket charges with steam to maintain 115.0° C (239.0° F). STATUS on the display shows **DOOR OPEN, READY,** or **JACKET CHARGE** depending upon status of the sterilizer. A cycle cannot be run with door open. The cycle may be run with the jacket still charging.

Press **CYCLE** button to select a cycle. The following display is shown for cycles 1 through 8. Corresponding cycle values appear on display.

Screen #95

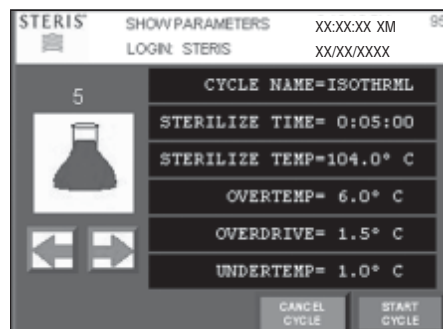

Press **RIGHT ARROW** button to show more cycle parameters. The following display appears:

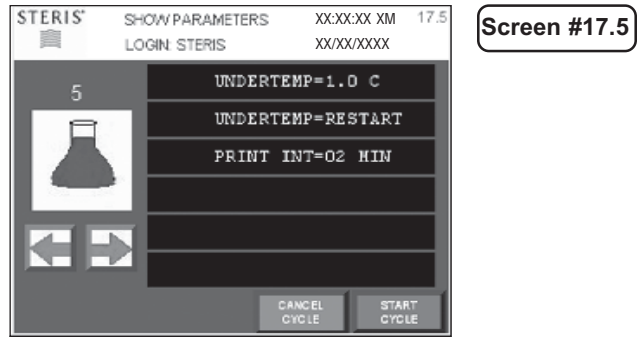

Press **LEFT ARROW** to show the previous values. Press **CANCEL CYCLE** to return to the operating mode screen (#2 or #19). Press **START CYCLE** button to start cycle.

*NOTE: If display shows **CLOSE DOOR(S)** message, close the door. The cycle does not start until door is closed.*

Press **PRINT CYCLE VALUES** button to print all cycle values. The following is a print example of all cycles values. (NOTE: STRL, CTRL, and Fo only appear if load probes are selected):

```

=====
==== CYCLE VALUES PRINTOUT ====
=====
XX:XX:XX XM                XX/XX/XX

LOGIN NAME:  STERIS

1.GRAVITY1
PURGE TIME= 2:00
STER TIME = 0:30:00
STER TEMP = 121.0 C
  OVERTEMP = 6.0 C
  OVERDRIVE = 1.5 C
  UNDERTEMP = 1.0 C RESUME
PRINT INT = 2 MIN
  VAC DRY = 10.0 inHg
  DRY TIME = 0:15:00
STRL CTRL = DRAIN
      Fo = 0
-----

2.GRAVITY2
PURGE TIME= 2:00
STER TIME = 0:30:00
STER TEMP = 121.0 C
  OVERTEMP = 6.0 C
  OVERDRIVE = 1.5 C
  UNDERTEMP = 1.0 C RESUME
PRINT INT = 2 MIN
  VAC DRY = 10.0 inHg
  DRY TIME = 0:15:00
STRL CTRL = DRAIN
      Fo = 0
-----

3.LIQUID3
PURGE TIME= 2:00
STER TIME = 0:45:00
STER TEMP = 121.0 C
  OVERTEMP = 6.0 C
  OVERDRIVE = 1.5 C
  UNDERTEMP = 1.0 C RESUME
PRINT INT = 2 MIN
STRL CTRL = DRAIN
      Fo = 0
-----

4.LIQUID4
PURGE TIME= 2:00
STER TIME = 0:45:00

```

```

UNDERTEMP = 1.0 C RESUME
PRINT INT = 2 MIN
STRL CTRL = DRAIN
      Fo = 0
-----
5.78 C
STER TIME = 0:30:00
STER TEMP = 78.0 C
  OVERTEMP = 6.0 C
  OVERDRIVE = 1.5 C
  UNDERTEMP = 1.0 C RESUME
PRINT INT = 2 MIN
-----
6.88 C
STER TIME = 0:30:00
STER TEMP = 88.0 C
  OVERTEMP = 6.0 C
  OVERDRIVE = 1.5 C
  UNDERTEMP = 1.0 C RESUME
PRINT INT = 2 MIN
-----
7.104 C
STER TIME = 0:30:00
STER TEMP = 104.0 C
  OVERTEMP = 6.0 C
  OVERDRIVE = 1.5 C
  UNDERTEMP = 1.0 C RESUME
PRINT INT = 2 MIN
-----
6.104 C
STER TIME = 0:30:00
STER TEMP = 104.0 C
  OVERTEMP = 6.0 C
  OVERDRIVE = 1.5 C
  UNDERTEMP = 1.0 C RESUME
PRINT INT = 2 MIN
-----

```

## 5.3 Status Buttons

Status screens are accessed by **PRES/TEMP**, **MACHINE I/O**, and **GRAPH** buttons. Press **PRES/TEMP** button to show Pressure/Temperature status screen.

*NOTE: LOAD 1 and F<sub>o</sub> appears if the load probe is configured.*

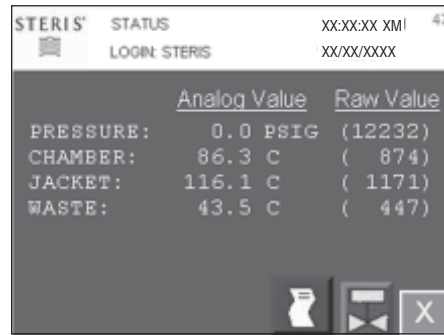

Screen #47

The status screen shows the current pressure and temperatures. Raw value is the analog value before it is scaled for pressure or temperature. This value is used for troubleshooting. Press **EXIT** button to return to the previous screen.

Press **MACHINE I/O** button to show machine I/O status. The following screen appears:

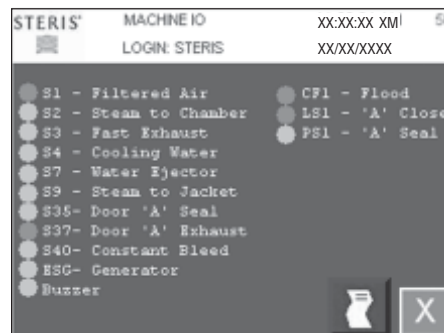

Screen #56

Gray circle next to device indicates that device is off or open. When gray circle turns red, that indicates that device is on or closed. Press **EXIT** button to return to the previous screen. Press **EXIT** button again to return to operating mode main menu screen shown below:

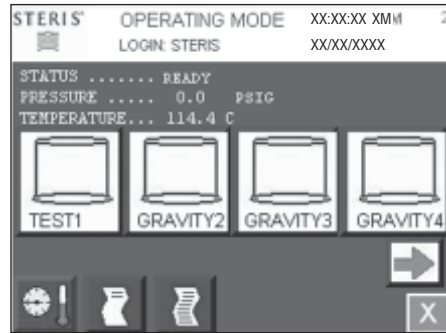

Screen #2

Press **PRINT STATUS** button to print current status. Following is an example status print:



Press **PRINT CYCLE VALUES** button to print all cycle values. The following is a print example of all cycles values. (NOTE: STRL, CTRL, and Fo only appear if load probes are selected):

```

=====
==== CYCLE VALUES PRINTOUT
====
=====
XX:XX:XX PM      XX/XX/XX

LOGIN NAME:  STERIS

1.GRAVITY1
PURGE TIME= 2:00
STER TIME = 0:30:00
STER TEMP = 121.0 C
  OVERTEMP = 6.0 C
OVERDRIVE = 1.5 C
UNDERTEMP = 1.0 C  RESUME
PRINT INT = 2 MIN
  VAC DRY = 10.0 inHg
  DRY TIME = 0:15:00
STRL CTRL = DRAIN
  Fo = 0
-----

2.GRAVITY2
PURGE TIME= 2:00
STER TIME = 0:30:00
STER TEMP = 121.0 C
  OVERTEMP = 6.0 C
OVERDRIVE = 1.5 C
UNDERTEMP = 1.0 C  RESUME
PRINT INT = 2 MIN
  VAC DRY = 10.0 inHg
  DRY TIME = 0:15:00
STRL CTRL = DRAIN
  Fo = 0
-----

3.GRAVITY3
PURGE TIME= 2:00
STER TIME = 0:30:00
STER TEMP = 121.0 C
  OVERTEMP = 6.0 C
OVERDRIVE = 1.5 C
UNDERTEMP = 1.0 C  RESUME
PRINT INT = 2 MIN
  VAC DRY = 10.0 inHg
  DRY TIME = 0:15:00
STRL CTRL = DRAIN
  Fo = 0
-----

4.GRAVITY4
PURGE TIME= 2:00
STER TIME = 0:30:00
STER TEMP = 121.0 C
  OVERTEMP = 6.0 C
OVERDRIVE = 1.5 C
UNDERTEMP = 1.0 C  RESUME
PRINT INT = 2 MIN

```

```

VAC DRY = 10.0 inHg
  DRY TIME = 0:15:00
STRL CTRL = DRAIN
  Fo = 0
-----

5.LIQUID5
PURGE TIME= 2:00
STER TIME = 0:30:00
STER TEMP = 121.0 C
  OVERTEMP = 6.0 C
OVERDRIVE = 1.5 C
UNDERTEMP = 1.0 C  RESUME
PRINT INT = 2 MIN
STRL CTRL = DRAIN
  Fo = 0
-----

6.LIQUID6
PURGE TIME= 2:00
STER TIME = 0:30:00
STER TEMP = 121.0 C
  OVERTEMP = 6.0 C
OVERDRIVE = 1.5 C
UNDERTEMP = 1.0 C  RESUME
PRINT INT = 2 MIN
STRL CTRL = DRAIN
  Fo = 0
-----

7.LIQUID7
PURGE TIME= 2:00
STER TIME = 0:45:00
STER TEMP = 121.0 C
  OVERTEMP = 6.0 C
OVERDRIVE = 1.5 C
UNDERTEMP = 1.0 C  RESUME
PRINT INT = 2 MIN
STRL CTRL = DRAIN
  Fo = 0
-----

8.LIQUID8
PURGE TIME= 2:00
STER TIME = 0:45:00
STER TEMP = 121.0 C
  OVERTEMP = 6.0 C
OVERDRIVE = 1.5 C
UNDERTEMP = 1.0 C  RESUME
PRINT INT = 2 MIN
STRL CTRL = DRAIN
  Fo = 0
-----

TOO LONG IN:
-----
  ACTIVATE SEAL = 1 m
    AIR BREAK = 5 m
      CHARGE = 60 m
DEACTIVATE SEAL= 1 m
  EVACUATE = 30 m
    EXHAUST = 10 m
  JACKET CHARGE = 60 m

```

Press **GRAPH** button during cycle to display a cycle graph of chamber, jacket, waste, and pressure analog values. An example screen is shown below:

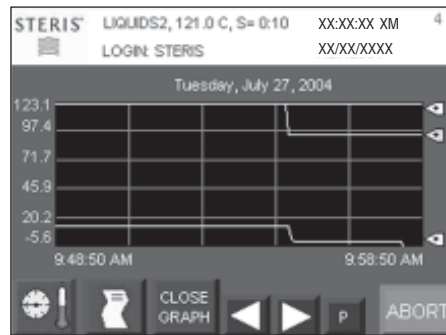

Screen #4

The graph displays analog values over a 10-minute period of time. Each analog value is represented by a different color. Press **STERIS** button to access the help screen shown below:

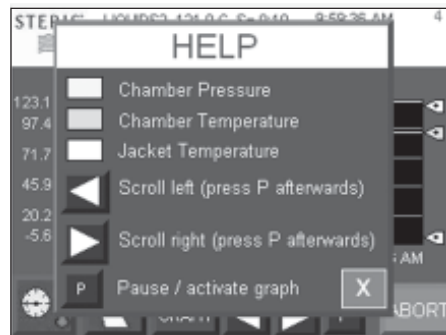

Screen #4

Refer to SECTION 5.5, COMPACT FLASH CARD, for a description of saving and retrieving data from compact flash card.



## 5.4 Printer Operation (Optional)

The sterilizer may be equipped with a printer the following two section provide instruction for operating the two style of printers. Observe the design of the printer used with you sterilizer (if present) and refer to the appropriate instructions.

### 5.4.1 Printer Operation (Optional Cybertech Printer)

The sterilizer may be equipped with an impact printer. See *SECTION 8, ROUTINE MAINTENANCE* section of this manual for information on how to change printer paper and ribbon. Refer to Figure 5-1.

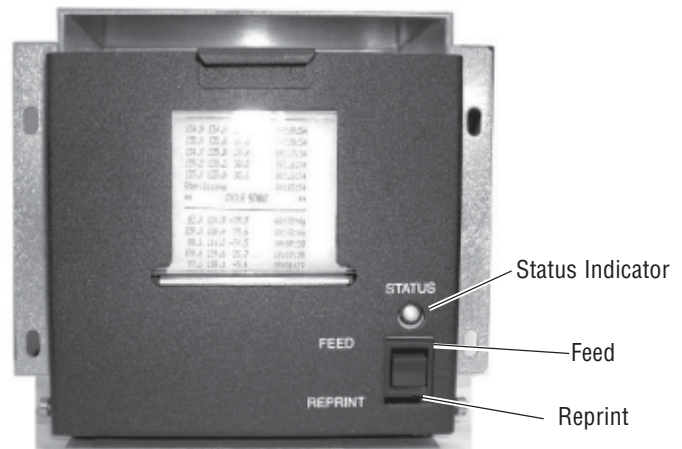

Figure 5-1. Optional Cybertech Printer

The printer produces a status print when the status print button is pressed, the cycle values, a start up banner, calibration values, and cycle values. It also prints any abnormal conditions, like alarms.

**FEED** – press the switch on the printer toward FEED label to generate a paper feed.

**REPRINT** – press the switch on the printer toward REPRINT label to generate a duplicate print of the last cycle run. The cycle remains in memory and multiple duplicate prints may be produced for that cycle, until another cycle is run.

**STATUS** light – If the status light blinks, the paper may need to be replaced. See *SECTION 8, ROUTINE MAINTENANCE*.

### 5.4.2 Printer Operation (Optional Mylox Printer)

The sterilizer may be equipped with a Mylox printer. See Section 8, Routine Maintenance for information on how to change printer paper and ribbon. Refer to Figure 5-2.

Press the print button on the control to produce a status print. Cycle values, start up banner, calibration values, and cycle progression are all given on the printout. Abnormal conditions, such as alarms, are also printed.

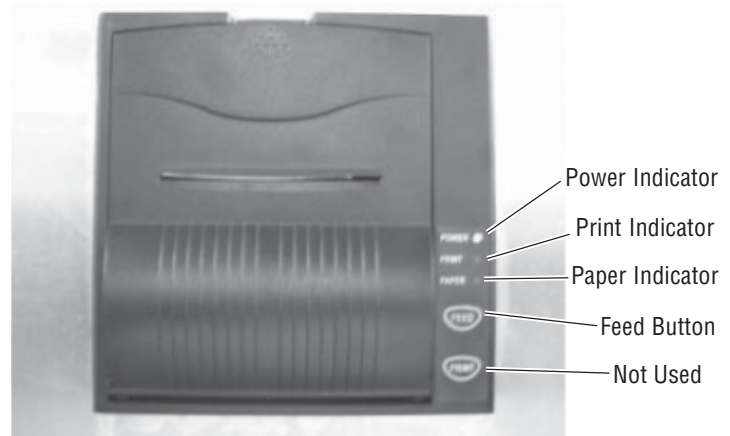

Figure 5-2. Optional Mylox Printer

**FEED** – press the switch on the printer toward the feed label to advance the paper.

**PRINT** – not used.

**POWER INDICATOR** – lit when the printer is on.

**PRINT INDICATOR** – lit during any printer activity (printing or paper feed).

**PAPER INDICATOR** – flashes red when paper may need to be replaced. Refer to *SECTION 8, ROUTINE MAINTENANCE* for paper changing procedure.

---

## 5.5 Compact Flash Card

---

The PanelView Plus® 600 display is equipped with a compact flash port. A compact flash card may be inserted into this port for saving cycle data.

**VERY IMPORTANT: The compact flash card must be inserted with the power off. Once the power is turned on, the display recognizes that the compact flash card is present and data may be stored to the card during cycle. If the compact flash card is inserted with the power on, the control cannot sense the card, and no data is stored to the card until the power is turned off and on.**

The compact flash card has the capability of holding 300,000 data items. It doesn't matter what size the compact flash card is, the card may only hold 300,000 data items. If more than 300,000 data items are stored on the card, the first data is lost and new data is inserted in its place. 300,000 data items are equivalent to over eight one-hour cycles.

**VERY IMPORTANT:** The display must be shut down in order to save the cycle data. If power is turned off, the data is lost. Shutdown the display by pressing the **6** (right upper most corner) on the following display:

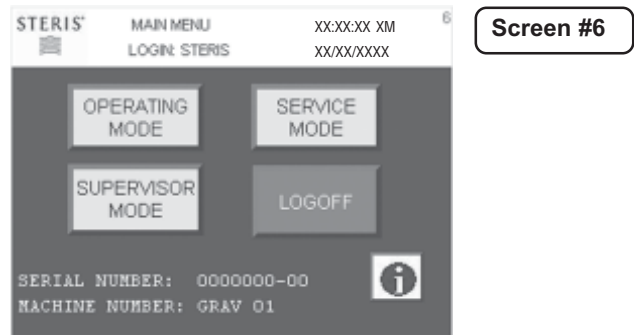

The display shuts down. The following display appears:



The compact flash card is now safe to remove. When the card is re-inserted, turn power OFF, re-insert the card and turn power back ON.

The PC needs the following files to convert saved data from compact flash card to a file Microsoft® Excel can read.

- DlgConverter.exe
- DBFtoXLS.exe

1. Run DlgConvert program first. The file from the compact flash card is **.log**. Convert this file to a **.dbf** file.
2. Run the DBFtoXLS program second. Enter in the created **.dbf** file, the **.log** file and a **.xls** file to be created.
3. After **.xls** file is created, this file may be imported into excel for use.

---

## 5.6 RS232 Download To PC

---

If the sterilizer is not equipped with a printer, a null modem serial cable may be inserted into the communication module on the back of the display. The PC receives the same data that would have gone to the printer.

If sterilizer is equipped with a printer, order kit **P338523-311** to retrieve same serial data going to printer. Using serial splitter, plug female end into communication module on back of PanelView 600 Plus. Plug cable into printer in one of the male plugs. Plug cable going to PC in other male plug. Use gender changer on back of PC.

PC needs serial communication software to retrieve data. HyperTerminal (provided with most PCs) may be used to collect data.

Settings for the PC need to be as follows:

Parity:	No parity
Parity Type:	Even
Bits per character:	8

## 6.1 Before Operating Sterilizer

Carefully review *SECTION 1, SAFETY PRECAUTIONS*, of this manual and below before operating sterilizer.



### CAUTION - POSSIBLE EQUIPMENT DAMAGE:

- Gasket must be fully retracted prior to operating sterilizer door.
- If 0 dry time is selected, sterilizer automatically initiates a vapor removal phase in place of drying. This phase can still draw a vacuum to 5 inHg. Consult device manufacturer's recommendations to ensure devices being processed can withstand this depth of vacuum.
- Lifting the chamber float switch when cleaning the chamber may cause the sterilizer control to initiate a Chamber Flooded alarm. If this alarm condition occurs, the operator must turn the control power OFF then ON to clear the alarm. The control power switch is located in the mechanical area at the side of the sterilizer. Placing the sterilizer in standby does not clear this alarm.
- Allow thermostatic traps to cool down to room temperature before removing cover. Since there is nothing to limit expansion, the bellows may rupture or fatigue if trap is opened while hot.
- Actuation at less than 75% of rated pressure can allow debris to contaminate the seat and cause the safety valve to leak. A leaking safety valve must be replaced.
- Insufficient service clearance will make repairs more difficult and time-consuming.
- Piping sized too small may cause water hammer, resulting in damage to the sterilizer.
- After installation, it is mandatory to brace piping at the drain funnel so that it will not move vertically.
- Make sure door opening is clear of any obstruction before closing the door(s).
- Do not attempt to open sterilizer door during manual operation unless chamber is at 0 psig (0 bar).
- Never use a wire brush, abrasives, or steel wool on door and chamber assembly. Do not use cleaners containing chloride on stainless-steel surfaces. Chloride-based cleaners will deteriorate stainless steel, eventually leading to failure of the vessel.
- Immediately wipe up saline solution spills on loading car, to prevent damage to stainless steel.
- Do not use cleaners containing chlorides on loading cars. Chloride-based cleaners will deteriorate the loading car metal.
- Sterilization of chloride-containing solutions (e.g., saline) can cause chamber corrosion and is not recommended by the manufacturer. If, however, chloride-containing solutions must be processed, clean the chamber after each use.
- Avoid damage to the integral steam generator daily. Flush the generator daily. Failure to flush generator daily will void the manufacturer's warranty.

The following steps must be performed prior to daily sterilizer usage.

1. Open chamber door and check drain strainer is clean and in place (see Figure 6-1).
2. Check chamber interior is clean and close chamber door. Refer to SECTION 8, ROUTINE MAINTENANCE, if cleaning is necessary.
3. Open front cabinet panel on load end of sterilizer. Verify steam and water supply valves to sterilizer are on (see Figure 6-2). Close cabinet panel.
4. If sterilizer is equipped with an integral electric steam generator, flush and start up generator as outlined in *Daily Generator Start Up Procedure* in this manual.
5. Open printer access door, if optional printer has been installed. Check sufficient amount of printer paper is available. A colored warning stripe is visible when paper roll is near end. Refer to SECTION 8, ROUTINE MAINTENANCE, if paper roll needs replaced.

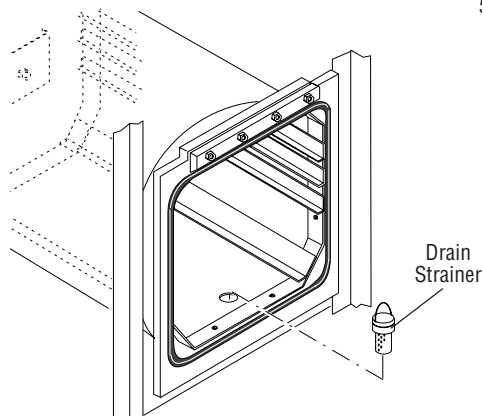

**Figure 6-1. Check Chamber Drain Strainer**

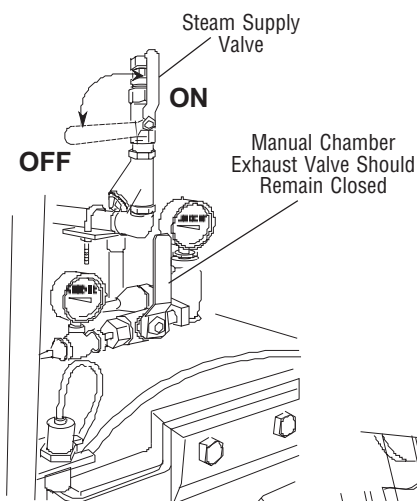

**Steam Valve Located Above Chamber Door**

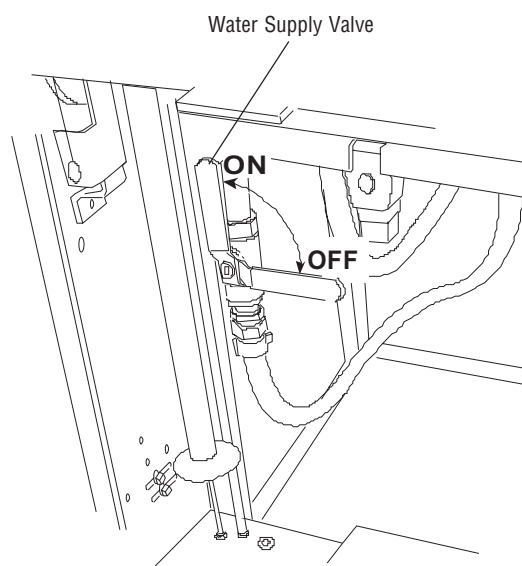

**Water Valve Located Below Chamber Door**

**Figure 6-2. Steam and Water Supply Valves**

6. Close printer access door. See control interface and operator mode – password entry sections of this manual for entering operating mode. Once operating mode is entered, steam enters sterilizer jacket and heats jacket to 115°C (239°F). The isothermal mode does not turn jacket on. Printer records sterilizer type.
7. Load sterilizer chamber as outlined in *SECTION 6.1.1, LOAD STERILIZER*.

### **6.1.1 Load Sterilizer**

1. Open chamber door.
2. Slide shelf half way out of sterilizer chamber (see Figure 6-3).
3. Place load on shelf and slide shelf back into chamber. Make sure shelves are completely inside chamber before closing door.
4. Close chamber door. Sterilizer is now ready to run a processing cycle. Refer to appropriate *CYCLE OPERATION*, included in this section, for instructions on running the cycle.

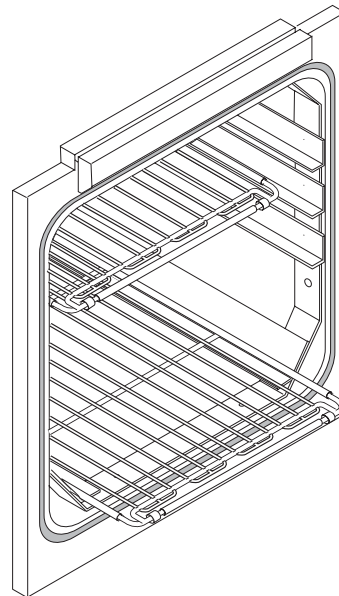

**Figure 6-3. Slide Shelf Half Way Out of Chamber**

### **6.1.2 Sterilizer Equipped with Loading Car**

1. Open chamber door.
2. Verify loading car is securely fastened to transfer carriage.
3. Move transfer carriage forward until carriage latches with chamber end frame (see Figure 6-4).

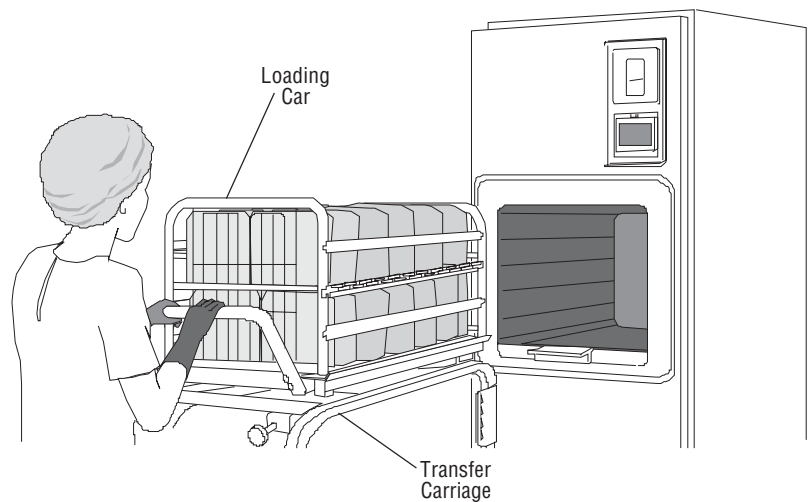

**Figure 6-4. Move Loaded Transfer Carriage in Position**

4. Verify transfer carriage is latched to chamber end frame by pulling carriage backward. If properly latched, carriage should remain stationary.
5. Once carriage is latched in place, release loading car from transfer carriage by lifting up carriage lock.
6. Carefully push loading car into sterilizer chamber. Make sure loading car is positioned in back detent inside chamber.
7. Pull carriage latch knob to disengage transfer carriage from chamber end frame. Move transfer carriage away from chamber.
8. Close chamber door. Sterilizer is now ready to run a processing cycle. Refer to appropriate *CYCLE OPERATION*, included in this section for instructions on running cycle.



---

## 6.2 Gravity Cycle

---

Carefully review *SECTION 1, SAFETY PRECAUTIONS*, and below before operating sterilizer.



### **WARNING – BURN HAZARD:**

- Do not attempt to open the sterilizer door if a **WATER IN CHAMBER ALARM** condition exists. Call a qualified service technician before attempting to use sterilizer further.
- After manual exhaust, steam may remain inside the chamber. Always wear protective gloves, apron, and a face shield when following emergency procedure to unload sterilizer. Stay as far back from the chamber opening as possible when opening the door.
- Allow sterilizer to cool to room temperature before performing any cleaning or maintenance procedures.
- Failure to shut off the steam supply when cleaning or replacing strainers can result in serious injury.
- Jacket pressure must be 0 psig (0 bar) before beginning work on the steam trap.
- Proper testing of the safety valve requires the valve to be operated under pressure. Exhaust from the safety valve is hot and can cause burns. Proper safety attire (gloves, eye protection, insulated overall) is required. Testing is to be performed by qualified service personnel only.
- When sterilizing liquids, to prevent personal injury or property damage resulting from bursting bottles and hot fluid, you must observe the following procedures:
  - Use **LIQUID** cycle only; no other cycle is safe for processing liquids.
  - Use only vented closures; do not use screw caps or rubber stoppers with crimped seal.
  - Use only Type 1 borosilicate glass bottles; do not use ordinary glass bottles or any container not designed for sterilization.
  - Do not allow hot bottles to be jolted; this can cause hot-bottle explosions. Do not move bottles if any boiling or bubbling is present.



**WARNING – EXPLOSION HAZARD:** This sterilizer is not designed to process flammable compounds.

The cycle is for sterilizing hard goods (e.g., empty glasses, non-porous loads). Run a GRAVITY CYCLE by pressing **GRAVITY** button from one of the operating mode screens (see OPERATING MODE section). The following screen appears (values are examples only):

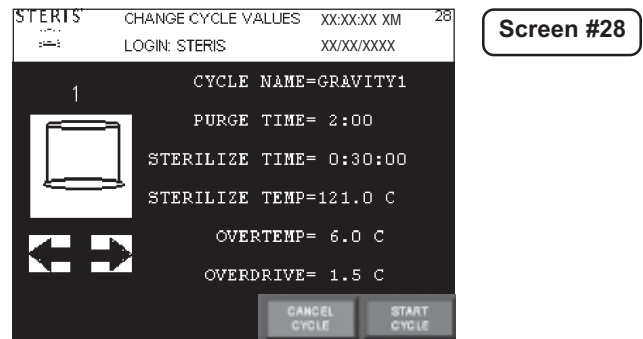

Press **CANCEL CYCLE** button to cancel cycle selected and return to the operating mode screen. Press **START CYCLE** to start the prevac cycle. If **CLOSE DOOR(S)** button is shown, close door(s).

The following display appears (see SECTION 5.3, STATUS BUTTONS, for description of buttons):

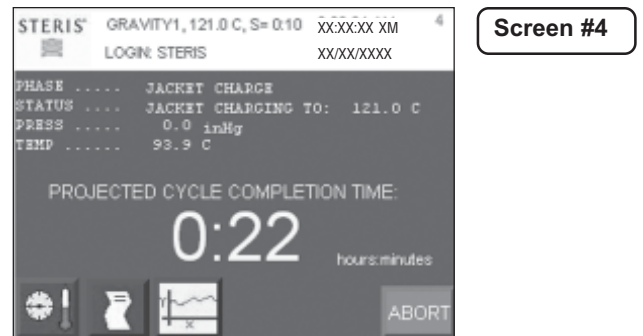

**JACKET CHARGE PHASE:** Jacket charge phase continues until jacket temperature is greater than set sterilizer temperature (example 120.0°C (248.0°F)). After jacket charge phase, the following display appears:

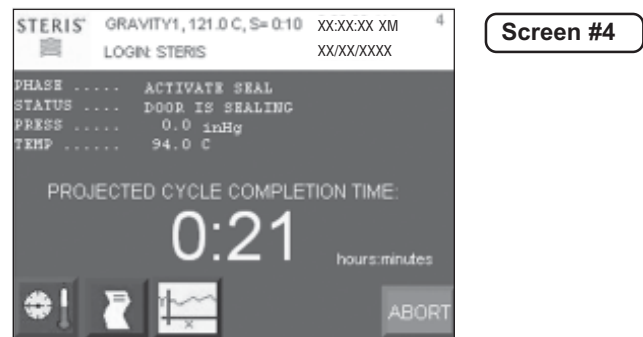

**ACTIVATE SEAL PHASE:** Door gasket seals with steam until door seal switch is closed. An additional 20 seconds elapses, after seal switch is closed, before phase is complete. After activate seal phase, the following display appears:



Screen #4

**PURGE PHASE:** Steam enters chamber from jacket to control pressure at 6 psig (0.41 bar). Fast exhaust and water ejector aid in removing air from chamber. After purge time, the following display appears:



Screen #4

**CHARGE PHASE:** Chamber charges with steam until chamber temperature reaches sterilize temperature setpoint. If load option is selected, phase holds until load temperature is greater than or equal to sterilize temperature. Waste temperature is controlled to maintain approximately 45.0°C (113.0°F). After phase is complete, the following screen is shown:



Screen #4

**STERILIZE PHASE:** Chamber temperature controls at sterilize temperature, plus overdrive (control temperature). Waste temperature is controlled to maintain approximately 45.0°C (113.0°F). After sterilize time is complete, the following screen appears:



Screen #4

**FAST EXHAUST PHASE:** Steam fast exhausts from chamber to 4.0 psig (0.28 bar). After chamber pressure is less than 4.0 psig (0.28 bar), the following display appears:



Screen #4

**VACUUM DRY PHASE:** A vacuum is pulled in the chamber to 10.0 inHg (-0.34 bar) (VACUUM DRY setpoint). After chamber pressure is less than 10.0 inHg (-0.34 bar), the following display appears:



Screen #4

**DRY PHASE:** During dry phase, vacuum continues to be pulled to the limit of the system for dry time. After dry time, the following screen appears:

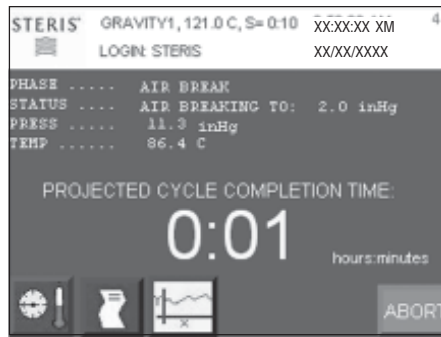

Screen #4

**AIR BREAK PHASE:** Chamber vacuum air breaks to 2.0 inHg (-0.17 bar) (-0.07 bar). After chamber pressure rises above 2.0 inHg (-0.17 bar), the following screen appears:

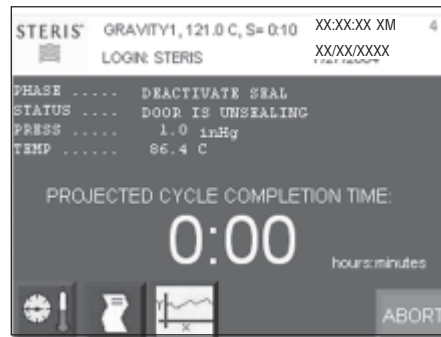

Screen #4

**DEACTIVATE SEAL PHASE:** Door unseals until seal pressure switch opens, and 20 seconds has elapsed. After phase is complete, the following display appears:



Screen #4

**COMPLETE PHASE:** Cycle is complete. Open door and unload chamber. Once door is open, display returns to main operating mode screen.

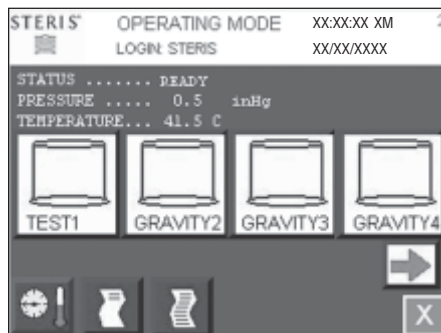

Screen #2

### Example of cycle tape.

```
=====
===== GRAVITY1 =====
=====
CYCLE START AT XX:XX:XXX
          ON XX/XX/XX

CYCLE COUNT          0
LOGIN NAME:          TOM

CYCLE NO.            2

    STER TEMP = 121.0 C
    CONTROL TEMP = 122.5 C
    STER TIME = 0:30:00
    DRY TIME = 0:01:00

          V=inHg
- TIME          T=C          P=psig
-----
C 11:48:24A      66.7          0.3V
C 11:49:24A      112.7         10.0P
S 11:49:43A      121.2         16.6P
S 11:51:43A      122.6         17.7P
S 11:53:43A      123.3         17.8P
S 11:55:43A      123.6         16.8P
S 11:57:43A      122.6         17.0P
S 11:59:43A      122.6         17.2P
S 12:01:43P      122.5         17.0P
S 12:03:43P      122.4         17.2P
S 12:05:43P      122.5         16.8P
S 12:07:43P      122.4         16.9P
S 12:11:43P      122.4         17.0P
S 12:13:43P      122.5         17.1P
S 12:15:43P      122.6         17.0P
S 12:17:43P      122.7         17.0P
S 12:19:43P      122.6         16.8P
E 12:19:44P      122.6         16.9P
E 12:19:54P      113.7          3.2P
E 12:20:03P      99.9          11.1V
E 12:21:03P      40.5          28.1V
Z 12:21:46P      68.4          0.5V

LOAD                                020903

CHAMBER TEMP MAX=124.8 C
CHAMBER TEMP MIN=121.2 C

CONDITON          = 1:19
STERILIZE         = 30:01
EXHAUST           = 1:42
TOTAL CYCLE       = 33:02

=====
===== READY TO UNLOAD =====
=====
```

---

## 6.3 Prevac Cycle (Optional)

---

Carefully review *SECTION 1, SAFETY PRECAUTIONS*, and below before operating sterilizer.



### **WARNING – BURN HAZARD:**

- Do not attempt to open the sterilizer door if a **WATER IN CHAMBER ALARM** condition exists. Call a qualified service technician before attempting to use sterilizer further.
- After manual exhaust, steam may remain inside the chamber. Always wear protective gloves, apron, and a face shield when following emergency procedure to unload sterilizer. Stay as far back from the chamber opening as possible when opening the door.
- Allow sterilizer to cool to room temperature before performing any cleaning or maintenance procedures.
- Failure to shut off the steam supply when cleaning or replacing strainers can result in serious injury.
- Jacket pressure must be 0 psig (0 bar) before beginning work on the steam trap.
- Proper testing of the safety valve requires the valve to be operated under pressure. Exhaust from the safety valve is hot and can cause burns. Proper safety attire (gloves, eye protection, insulated overall) is required. Testing is to be performed by qualified service personnel only.
- When sterilizing liquids, to prevent personal injury or property damage resulting from bursting bottles and hot fluid, you must observe the following procedures:
  - Use **LIQUID** cycle only; no other cycle is safe for processing liquids.
  - Use only vented closures; do not use screw caps or rubber stoppers with crimped seal.
  - Use only Type 1 borosilicate glass bottles; do not use ordinary glass bottles or any container not designed for sterilization.
  - Do not allow hot bottles to be jolted; this can cause hot-bottle explosions. Do not move bottles if any boiling or bubbling is present.



**WARNING – EXPLOSION HAZARD:** This sterilizer is not designed to process flammable compounds.

The cycle is for sterilizing wrapped goods (e.g., instrument trays, textile packs, and instrument containers).

Run a **PREVAC CYCLE** by pressing **PREVAC** button from one of the operating mode screens (see OPERATING MODE section). The following screen appears (values are examples only):

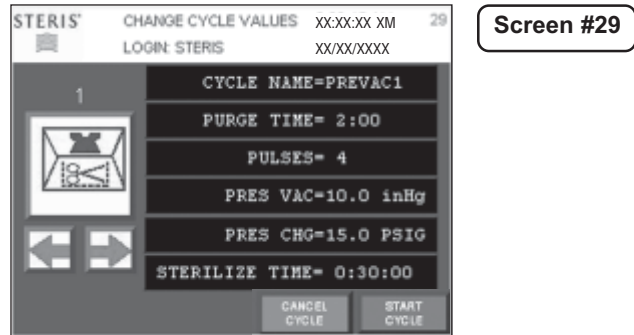

Press **CANCEL CYCLE** button to cancel cycle selected and return to operating mode screen. Press **START CYCLE** to start prevac cycle. If **CLOSE DOOR(S)** button is shown, close door(s).

The following display appears (see SECTION 5, STATUS BUTTONS, for description of buttons):

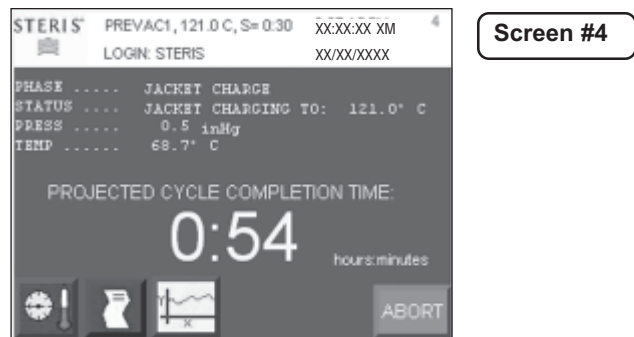

**JACKET CHARGE PHASE:** Jacket charge phase continues until jacket temperature is greater than set sterilizer temperature (example 121.0°C (250.0°F)). After jacket charge phase, the following display appears:

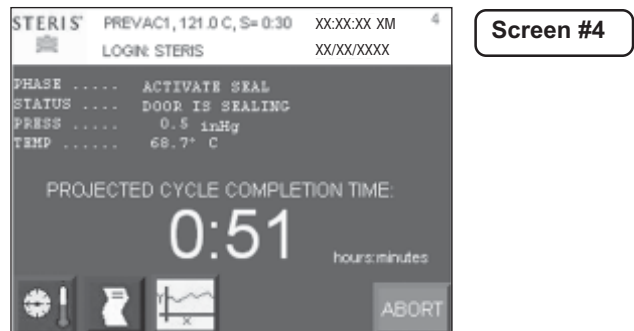

**ACTIVATE SEAL PHASE:** Door gasket seals with steam until door seal switch is closed. An additional 20 seconds elapses, after seal switch is closed, before the phase is complete. After activate seal phase, the following display appears:



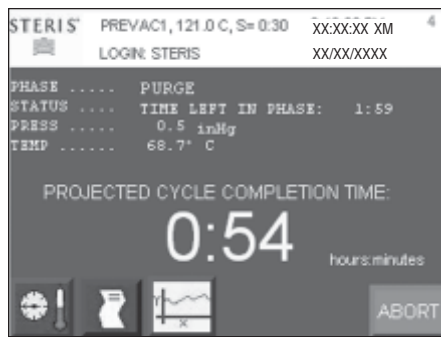

Screen #4

**PURGE PHASE:** Steam enters chamber from jacket to control pressure at 6 psig (0.41 bar). Fast exhaust and water ejector aid in removing air from chamber. After purge time, the following display appears:

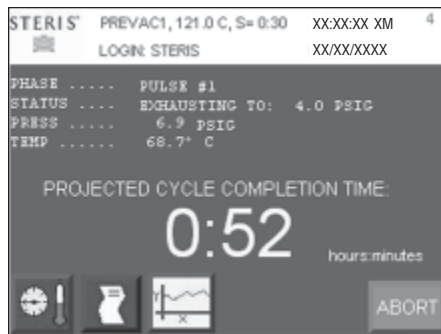

Screen #4

**PULSE EXHAUST PHASE:** Chamber exhausts to 4.0psig (0.28 bar) (0.27 bar). Waste temperature is controlled to maintain approximately 45.0°C (113.0°F). Jacket temperature is controlled to maintain approximately 122.5 °C (253.0°F) in jacket. After phase is complete, the following screen appears:

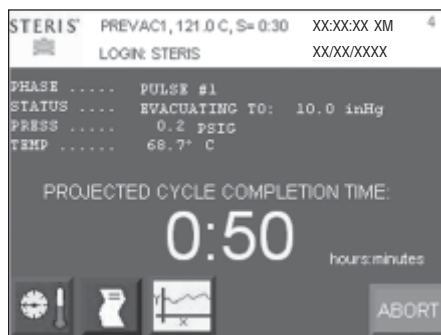

Screen #4

**PULSE EVACUATE PHASE:** Chamber evacuates to PULSE VACUUM setpoint (default 10.0 inHg (-0.34 bar) (0.34 bar). Waste temperature is controlled to maintain approximately 45.0°C (113.0°F). Jacket temperature is controlled to maintain approximately 122.5 C (253.0°F) in the jacket. After phase is complete, the following screen appears:



Screen #4

**PULSE CHARGE PHASE:** Chamber charges with steam to PULSE CHARGE setpoint (default 26.0 psig (0.34 bar)). PULSE EXHAUST, PULSE EVACUATE, and PULSE CHARGE repeats for the number of pulses selected. After final PULSE EVACUATE phase is complete, the following screen appears:



Screen #4

**CHARGE PHASE:** Chamber charges with steam until chamber temperature reaches sterilize temperature setpoint. If load option is selected, phase holds until load temperature is greater than or equal to sterilize temperature. Waste temperature is controlled to maintain approximately 45.0°C (113.0°F).

After phase is complete, the following screen is shown:

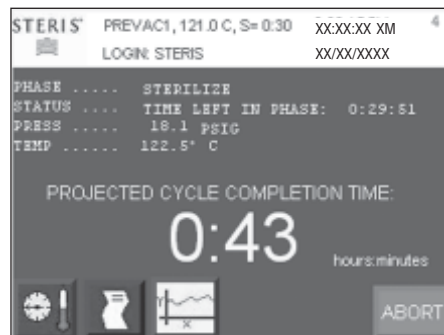

Screen #4

**STERILIZE PHASE:** Chamber temperature controls at sterilize temperature, plus overdrive (control temperature). Waste temperature is controlled to maintain approximately 45.0°C (113.0°F). After sterilize time is complete, the following screen appears:

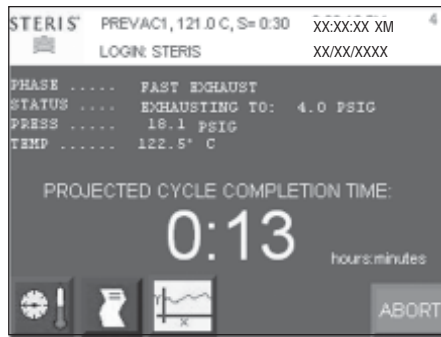

Screen #4

**FAST EXHAUST PHASE:** Steam fast exhausts from chamber to 4.0 psig (0.28 bar). After chamber pressure is less than 4.0 psig (0.28 bar), the following display appears:

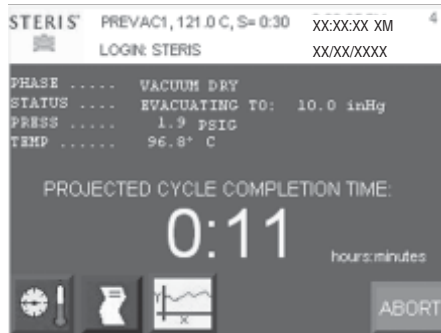

Screen #4

**VACUUM DRY PHASE:** A vacuum is pulled in the chamber to 10.0 inHg (-0.34 bar) (VACUUM DRY setpoint). After chamber pressure is less than 10.0 inHg (-0.34 bar), the following display appears:

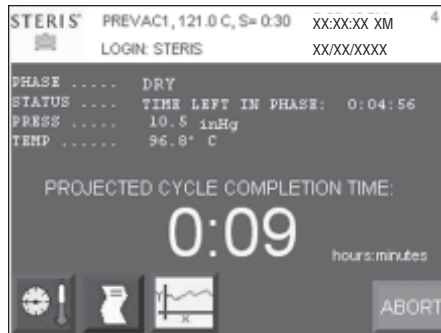

Screen #4

**DRY PHASE:** During dry phase, vacuum continues to be pulled to the limit of the system for dry time. After dry time, the following screen appears:

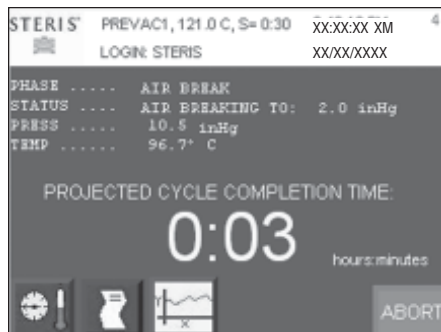

Screen #4

**AIR BREAK PHASE:** Chamber vacuum air breaks to 2.0 inHg (-0.17 bar). After chamber pressure rises above 2.0 inHg (-0.17 bar), the following screen appears:

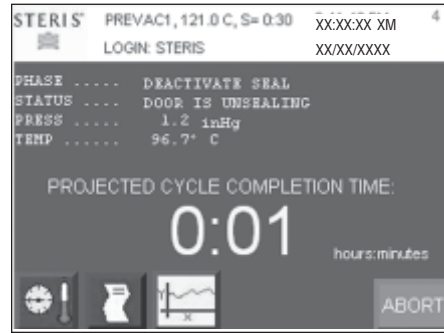

**Screen #4**

**DEACTIVATE SEAL PHASE:** Door unseals until seal pressure switch opens, and 20 seconds has elapsed. After phase is complete, the following display appears:

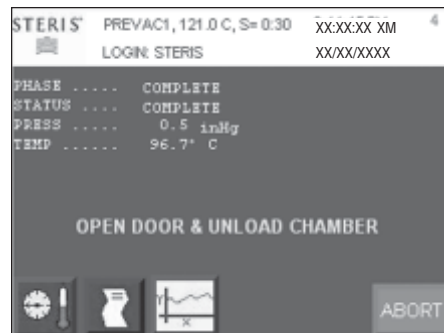

**Screen #4**

**COMPLETE PHASE:** Cycle is complete. Open door and unload chamber. Once door is open, display returns to main operating mode screen.

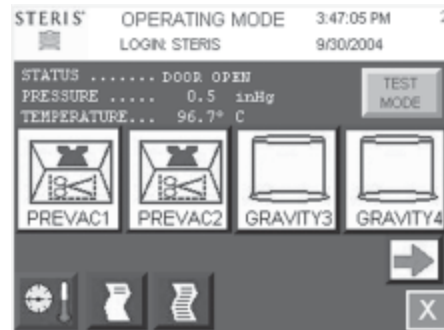

**Screen #2**

### Example of cycle tape.

```

=====
===== PREVAC1 =====
=====
CYCLE START AT XX:XX:XXX
              ON XX/XX/XX

CYCLE COUNT          0
LOGIN NAME:          TOM

CYCLE NO.            2

  STER TEMP = 121.0 C
CONTROL TEMP = 122.5 C
  STER TIME = 0:15:00
  DRY TIME  = 0:05:00

- TIME              T=C          V=inHg
                      P=psig
-----
C 11:48:24A        66.7          0.3V
C 11:50:24A        112.7         6.0P
C 11:51:22A        100.0        10.0V
C 11:51:50A         90.0        15.0P
C 11:52:15A        112.7         4.0P
C 11:52:55A        100.0        10.0V
C 11:53:17A         90.0        15.0P
C 11:53:45A        112.7         4.0P
C 11:54:08A        100.0        10.0V
C 11:54:47A         90.0        15.0P
C 11:55:00A        112.7         4.0P
C 11:55:43A        100.0        10.0V
S 11:57:43A        121.2        16.6P
S 11:59:43A        122.6        17.7P
S 12:01:43A        123.3        17.8P
S 12:03:43A        123.6        16.8P
S 12:05:43A        122.6        17.0P
S 12:07:43A        122.6        17.2P
S 12:09:43P        122.5        17.0P
S 12:11:43P        122.5        17.0P
E 12:12:44P        122.6        16.9P
E 12:13:14P        113.7         3.2P
E 12:15:03P         99.9        11.1V
E 12:20:03P         40.5        28.1V
Z 12:21:46P         68.4         0.5V

LOAD                020903

CHAMBER TEMP MAX=124.8 C
CHAMBER TEMP MIN=121.2 C

CONDITON           = 9:20
STERILIZE           = 15:00
EXHAUST             = 9:03
TOTAL CYCLE         = 23:23

=====
=====  READY TO UNLOAD  =====
=====

```

---

## 6.4 Liquid Cycle

---

Carefully review *SECTION 1, SAFETY PRECAUTIONS*, and below before operating sterilizer.



### **WARNING – BURN HAZARD:**

- Do not attempt to open the sterilizer door if a **WATER IN CHAMBER ALARM** condition exists. Call a qualified service technician before attempting to use sterilizer further.
- After manual exhaust, steam may remain inside the chamber. Always wear protective gloves, apron, and a face shield when following emergency procedure to unload sterilizer. Stay as far back from the chamber opening as possible when opening the door.
- Allow sterilizer to cool to room temperature before performing any cleaning or maintenance procedures.
- Failure to shut off the steam supply when cleaning or replacing strainers can result in serious injury.
- Jacket pressure must be 0 psig (0 bar) before beginning work on the steam trap.
- Proper testing of the safety valve requires the valve to be operated under pressure. Exhaust from the safety valve is hot and can cause burns. Proper safety attire (gloves, eye protection, insulated overall) is required. Testing is to be performed by qualified service personnel only.
- When sterilizing liquids, to prevent personal injury or property damage resulting from bursting bottles and hot fluid, you must observe the following procedures:
  - Use LIQUID cycle only; no other cycle is safe for processing liquids.
  - Use only vented closures; do not use screw caps or rubber stoppers with crimped seal.
  - Use only Type 1 borosilicate glass bottles; do not use ordinary glass bottles or any container not designed for sterilization.
  - Do not allow hot bottles to be jolted; this can cause hot-bottle explosions. Do not move bottles if any boiling or bubbling is present.



**WARNING – EXPLOSION HAZARD:** This sterilizer is not designed to process flammable compounds.

This cycle is used for sterilizing liquids in heat-resistant containers with vented closures.

Run a LIQUID CYCLE by pressing **LIQUID** button from one of the operating mode screens (see OPERATING MODE section). The following screen appears (values are examples only):

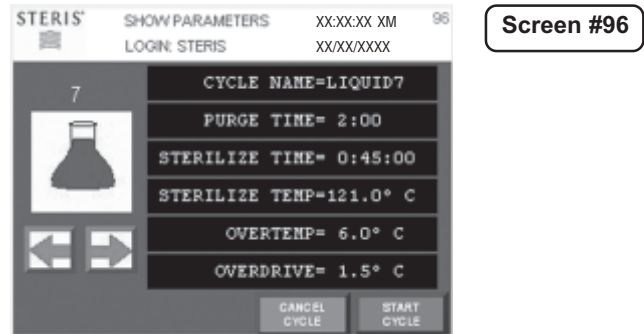

Screen #96

Press **CANCEL CYCLE** button to cancel cycle selected and return to operating mode screen. Press **START CYCLE** to start the prevac cycle. If **CLOSE DOOR(S)** button is shown, close door(s).

The following display appears (see SECTION 5.3, STATUS BUTTONS, for description of buttons):

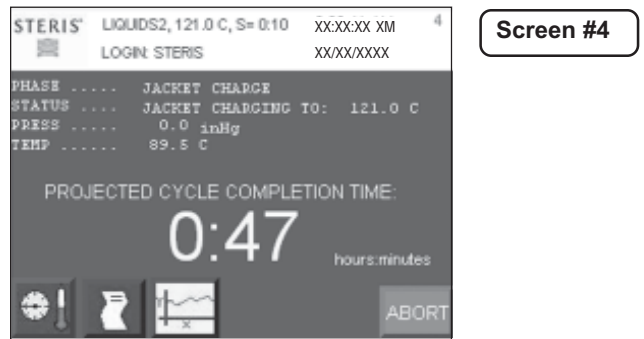

Screen #4

**JACKET CHARGE PHASE:** Jacket charge phase continues until jacket temperature is greater than set sterilizer temperature (example 120.0°C (248.0°F)). After jacket charge phase, the following display appears:

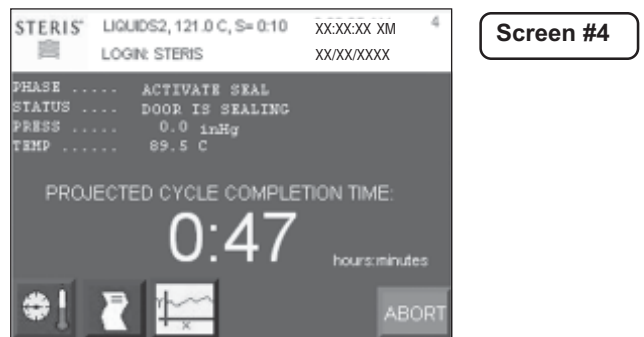

Screen #4

**ACTIVATE SEAL PHASE:** Door gasket seals with steam until door seal switch is closed. An additional 20 seconds elapses, after seal switch is closed, before phase is complete. After activate seal phase, the following display appears:

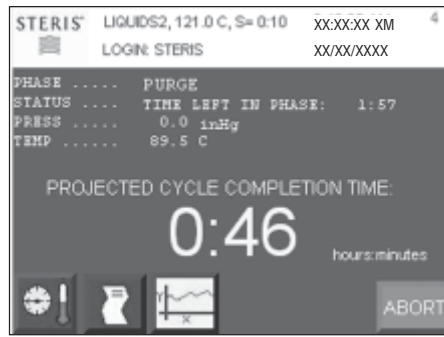

Screen #4

**PURGE PHASE:** Steam enters chamber from jacket to control pressure at 6 psig (0.41 bar). Fast exhaust and water ejector aid in removing air from chamber. After purge time, the following display appears:

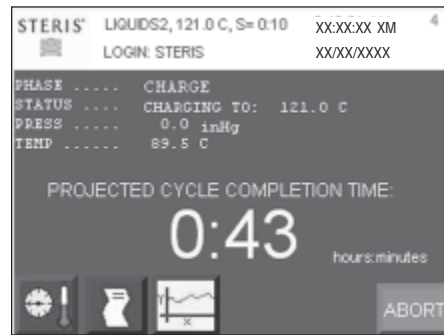

Screen #4

**CHARGE PHASE:** Chamber charges with steam until chamber temperature reaches sterilize temperature setpoint. If load option is selected, phase holds until load temperature is greater than or equal to sterilize temperature. Waste temperature is controlled to maintain approximately 45.0°C (113.0°F). After phase is complete, the following screen is shown:

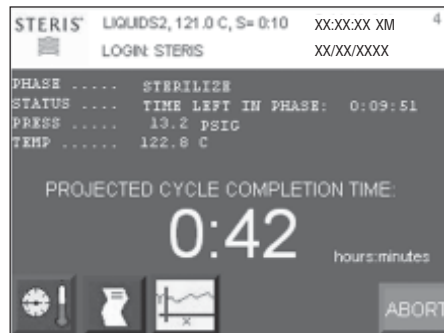

Screen #4

**STERILIZE PHASE:** Chamber temperature controls at sterilize temperature, plus overdrive (control temperature). Waste temperature is controlled to maintain approximately 45.0°C (113.0°F). After sterilize time is complete, the following screen appears:



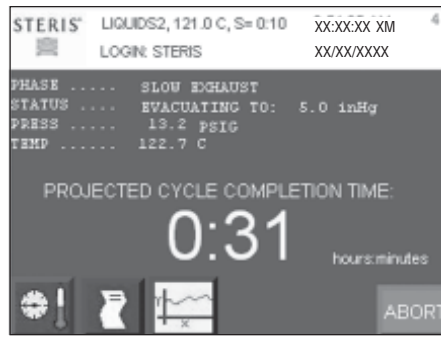

Screen #4

**SLOW EXHAUST PHASE:** Steam slowly exhausts from chamber to 5.0 inHg (0.17 bar). Pressure rate controls at 1.6 psi/minute (0.11 bar) to 4.2 psig (0.29 bar) and at 0.6 psi/minute (0.04 bar) to 5.0 inHg (0.17 bar). After chamber pressure is less than 4.0 psig (0.28 bar) (0.28 bar), the following display appears:

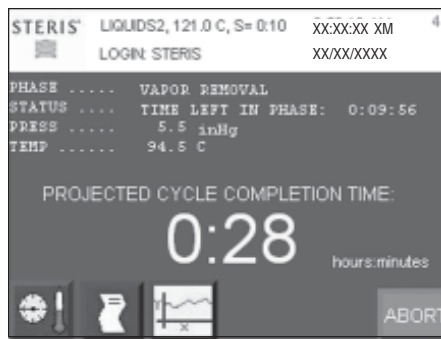

Screen #4

**VAPOR REMOVAL PHASE:** Vapors in chamber vents for 10 minutes. After phase time is complete, the following screen appears:

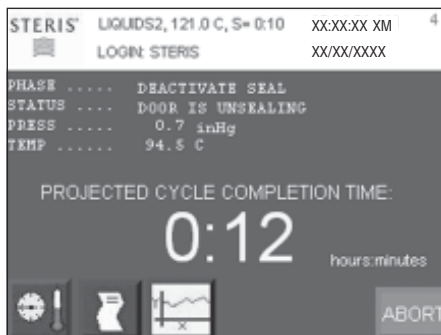

Screen #4

**DEACTIVATE SEAL PHASE:** Door unseals until seal pressure switch opens and 20 seconds has elapsed. After phase is complete, the following display appears:



Screen #4

**COMPLETE PHASE:** Cycle is complete. Open door and unload chamber. Once door is open, display returns to main operating mode screen.

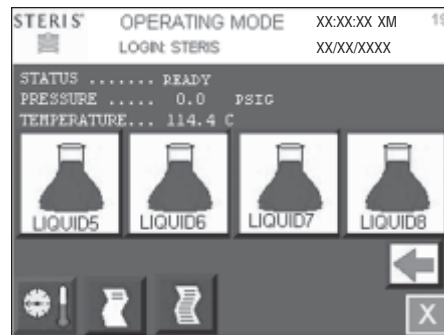

Screen #19

### Example of cycle tape.

```
=====
===== LIQUID3 =====
=====
CYCLE START AT XX:XX:XXX
          ON XX/XX/XX

CYCLE COUNT          0
LOGIN NAME:          TOM

CYCLE NO.            2

    STER TEMP = 121.0 C
CONTROL TEMP = 122.5 C
    STER TIME = 0:45:00

- TIME              T=C          V=inHg
                    P=psig
-----
C 11:48:24A        66.7          0.3V
C 11:49:24A        112.7         10.0P
S 11:49:43A        121.2         16.6P
S 11:51:43A        122.6         17.7P
S 11:53:43A        123.3         17.8P
S 11:55:43A        123.6         16.8P
S 11:57:43A        122.6         17.0P
S 11:59:43A        122.6         17.2P
S 12:01:43P        122.5         17.0P
S 12:03:43P        122.4         17.2P
S 12:05:43P        122.5         16.8P
S 12:07:43P        122.4         16.9P
S 12:11:43P        122.4         17.0P
S 12:13:43P        122.5         17.1P
S 12:15:43P        122.6         17.0P
S 12:17:43P        122.7         17.0P
S 12:19:43P        122.6         16.8P
E 12:19:44P        122.6         16.9P
Z 12:39:03P        89.9          5.1V

LOAD                080804

CHAMBER TEMP MAX=124.8 C
CHAMBER TEMP MIN=121.2 C

CONDITON           = 1:19
STERILIZE          = 30:01
EXHAUST            = 21:42
TOTAL CYCLE        = 42:01

=====
===== READY TO UNLOAD =====
=====
```

---

## 6.5 Isothermal Cycle (Optional)

---

Carefully review *SECTION 1, SAFETY PRECAUTIONS*, and below before operating sterilizer.



### **WARNING – BURN HAZARD:**

- Do not attempt to open the sterilizer door if a **WATER IN CHAMBER ALARM** condition exists. Call a qualified service technician before attempting to use sterilizer further.
- After manual exhaust, steam may remain inside the chamber. Always wear protective gloves, apron, and a face shield when following emergency procedure to unload sterilizer. Stay as far back from the chamber opening as possible when opening the door.
- Allow sterilizer to cool to room temperature before performing any cleaning or maintenance procedures.
- Failure to shut off the steam supply when cleaning or replacing strainers can result in serious injury.
- Jacket pressure must be 0 psig (0 bar) before beginning work on the steam trap.
- Proper testing of the safety valve requires the valve to be operated under pressure. Exhaust from the safety valve is hot and can cause burns. Proper safety attire (gloves, eye protection, insulated overall) is required. Testing is to be performed by qualified service personnel only.
- When sterilizing liquids, to prevent personal injury or property damage resulting from bursting bottles and hot fluid, you must observe the following procedures:
  - Use **LIQUID** cycle only; no other cycle is safe for processing liquids.
  - Use only vented closures; do not use screw caps or rubber stoppers with crimped seal.
  - Use only Type 1 borosilicate glass bottles; do not use ordinary glass bottles or any container not designed for sterilization.
  - Do not allow hot bottles to be jolted; this can cause hot-bottle explosions. Do not move bottles if any boiling or bubbling is present.



**WARNING – EXPLOSION HAZARD:** This sterilizer is not designed to process flammable compounds.

The cycle is designed for low temperature processing (e.g., fractional sterilization, pasteurization) at 78 to 110°C (172 to 230°F).

Run an ISOTHERMAL CYCLE by pressing **ISOTHERMAL** button from iso mode operating screen. The screen is shown below:

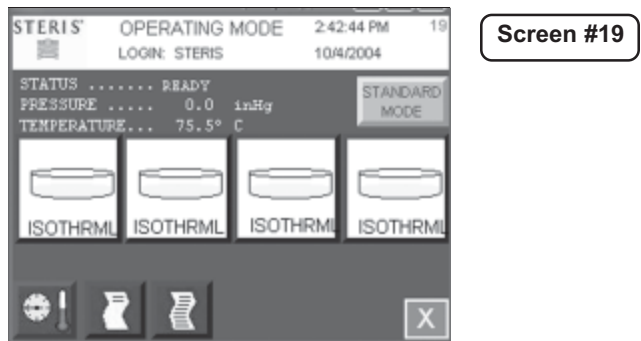

The following screen is shown (values are examples only):

Press **CANCEL CYCLE** button to cancel cycle selected and return to operating mode screen. Press **START CYCLE** to start the isothermal cycle. If **CLOSE DOOR(S)** button is shown, close door(s). See section on OPERATING MODE - ISOTHERMAL MODE to change from the STANDARD MODE to ISO MODE.

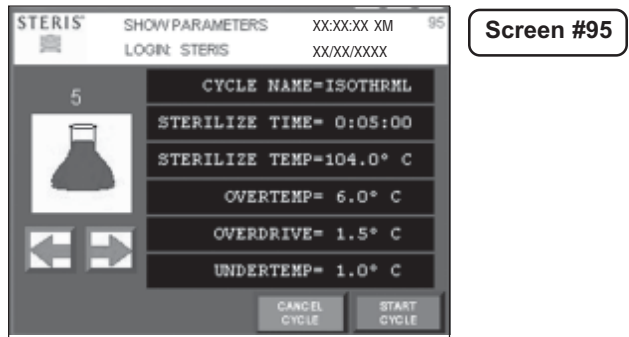

The following display is shown:

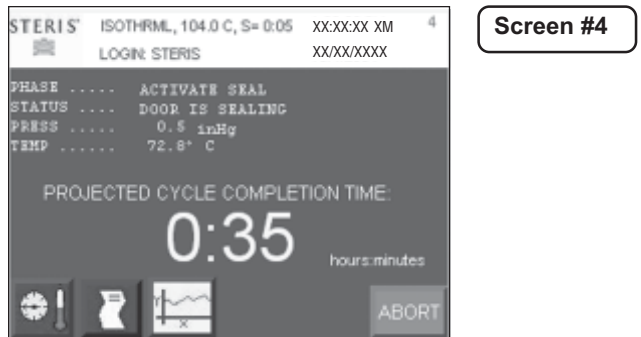

**ACTIVATE SEAL PHASE:** Door gasket seals with steam until door seal switch is closed. An additional 20 seconds elapses, after seal switch is closed, before phase is complete. After activate seal phase, the following display is shown:

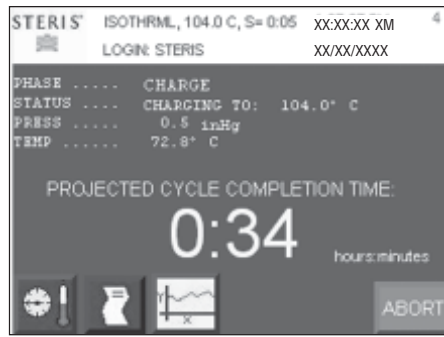

Screen #4

**CHARGE PHASE:** Chamber charges with steam until chamber temperature reaches sterilize temperature. Waste temperature is controlled to maintain approximately 45.0°C (113.0°F).

After phase is complete, the following screen is shown:

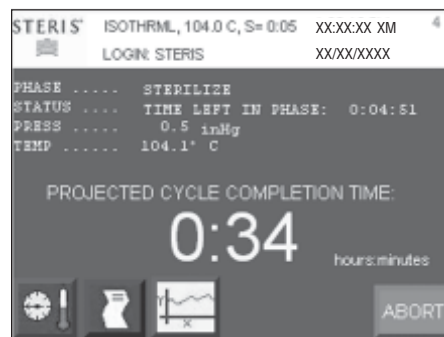

Screen #4

**STERILIZE PHASE:** Chamber temperature controls at sterilize temperature plus overdrive. Waste temperature is controlled to maintain approximately 45.0°C (113.0°F). After sterilize time is complete, the following screen is shown:

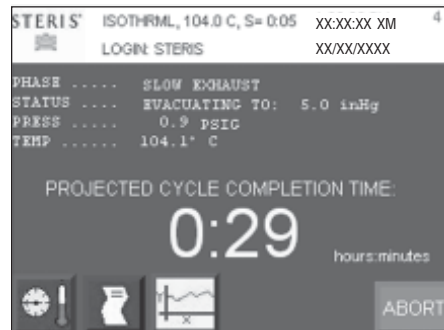

Screen #4

**SLOW EXHAUST PHASE:** Steam slowly exhausts from chamber to 5.0 inHg (0.17 bar). Pressure rate controls at 1.6 psi/minute (0.11 bar) to 4.2 psig (0.29 bar) and at 0.6 psi/minute (0.04 bar) to 5.0 inHg (0.17 bar).

After chamber pressure is less than 5.0 inHg (0.17 bar), the following display is shown:

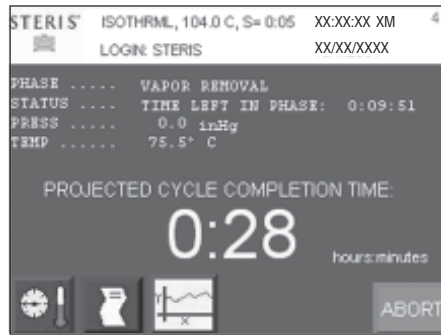

Screen #4

**VAPOR REMOVAL PHASE:** Vapors in chamber vents for 10 minutes. After time is complete, the following screen is shown:



Screen #4

**DEACTIVATE SEAL PHASE:** Door unseals until seal pressure switch opens and 20 seconds has elapsed.

After phase is complete, the following display is shown:

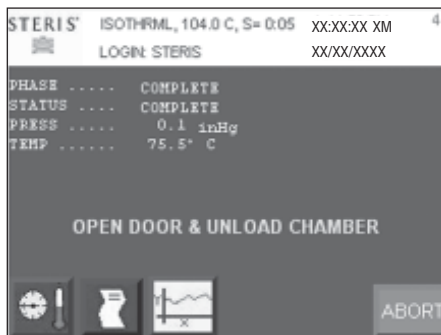

Screen #4

**COMPLETE PHASE:** Cycle is complete. Open door and unload chamber. Once door is open, display returns to main operating mode screen shown below:

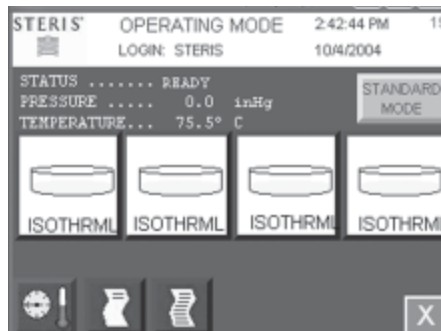

Screen #19

### Example of cycle tape.

```
=====
===== ISOTHRML =====
=====
CYCLE START AT XX:XX:XXX
              ON  XX/XX/XX

CYCLE COUNT          0
LOGIN NAME:          TOM

CYCLE NO.            5

    STER TEMP = 104.0 C
CONTROL TEMP = 104.0 C
    STER TIME = 0:45:00

- TIME              T=C          V=inHg
                      P=psig
-----
C 11:48:24A        66.7          0.3V
C 11:49:24A        112.7         10.0P
S 11:49:43A        121.2         16.6P
S 11:51:43A        122.6         17.7P
S 11:53:43A        123.3         17.8P
S 11:55:43A        123.6         16.8P
S 11:57:43A        122.6         17.0P
S 11:59:43A        122.6         17.2P
S 12:01:43P        122.5         17.0P
S 12:03:43P        122.4         17.2P
S 12:05:43P        122.5         16.8P
S 12:07:43P        122.4         16.9P
S 12:11:43P        122.4         17.0P
S 12:13:43P        122.5         17.1P
S 12:15:43P        122.6         17.0P
S 12:17:43P        122.7         17.0P
S 12:19:43P        122.6         16.8P
E 12:19:44P        122.6         16.9P
Z 12:39:03P        89.9          5.1V

LOAD                080804

CHAMBER TEMP MAX=124.8 C
CHAMBER TEMP MIN=121.2 C

CONDITON           = 1:19
STERILIZE          = 30:01
EXHAUST            = 21:42
TOTAL CYCLE        = 42:01

=====
===== READY TO UNLOAD =====
=====
```



---

## 6.6 Bowie-Dick Warmup Cycle (Only On Prevacuum Sterilizers)

---

Carefully review *SECTION 1, SAFETY PRECAUTIONS*, and below before operating sterilizer.



### WARNING – BURN HAZARD:

- Do not attempt to open the sterilizer door if a **WATER IN CHAMBER ALARM** condition exists. Call a qualified service technician before attempting to use sterilizer further.
- After manual exhaust, steam may remain inside the chamber. Always wear protective gloves, apron, and a face shield when following emergency procedure to unload sterilizer. Stay as far back from the chamber opening as possible when opening the door.
- Allow sterilizer to cool to room temperature before performing any cleaning or maintenance procedures.
- Failure to shut off the steam supply when cleaning or replacing strainers can result in serious injury.
- Jacket pressure must be 0 psig (0 bar) before beginning work on the steam trap.
- Proper testing of the safety valve requires the valve to be operated under pressure. Exhaust from the safety valve is hot and can cause burns. Proper safety attire (gloves, eye protection, insulated overall) is required. Testing is to be performed by qualified service personnel only.
- When sterilizing liquids, to prevent personal injury or property damage resulting from bursting bottles and hot fluid, you must observe the following procedures:
  - Use LIQUID cycle only; no other cycle is safe for processing liquids.
  - Use only vented closures; do not use screw caps or rubber stoppers with crimped seal.
  - Use only Type 1 borosilicate glass bottles; do not use ordinary glass bottles or any container not designed for sterilization.
  - Do not allow hot bottles to be jolted; this can cause hot-bottle explosions. Do not move bottles if any boiling or bubbling is present.



**WARNING – EXPLOSION HAZARD:** This sterilizer is not designed to process flammable compounds.

The cycle is used to warm up sterilizer shelves, door, and jacket before a DART (Bowie-Dick) cycle is run.

Run a DART WARMUP CYCLE by pressing **BOWIE-DICK WARMUP** button from the following screen.

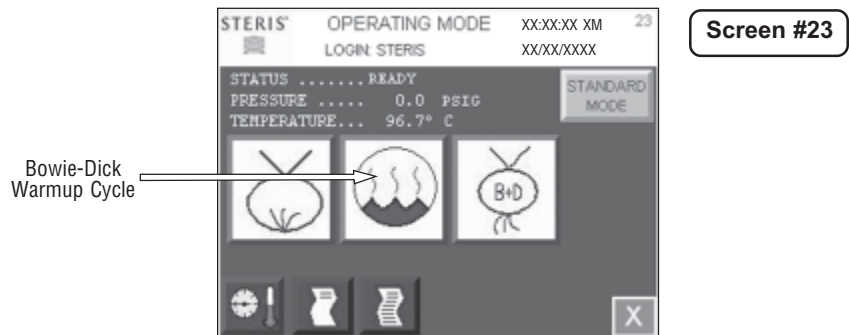

This screen is obtained by pressing **TEST MODE** button on screen #2 or screen #19. The following display is shown:

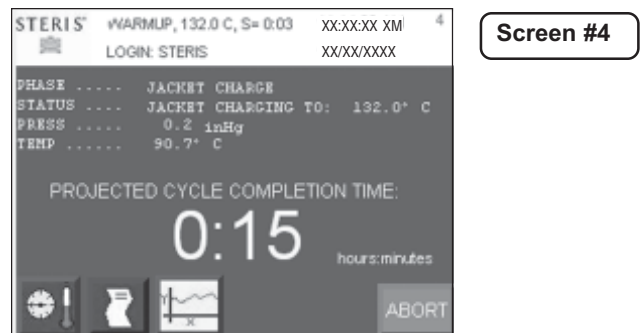

**JACKET CHARGE PHASE:** Jacket charge phase continues until jacket temperature is greater than 132.0°C (270.0°F). After jacket charge phase, the following display appears:

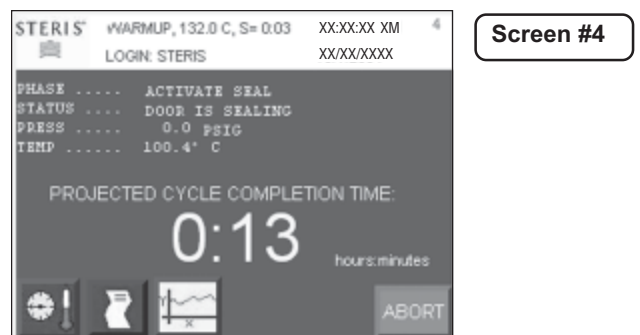

**ACTIVATE SEAL PHASE:** Door gasket seals with steam until door seal switch is closed. An additional 20 seconds elapses, after seal switch is closed, before phase is complete. After activate seal phase, the following display appears:

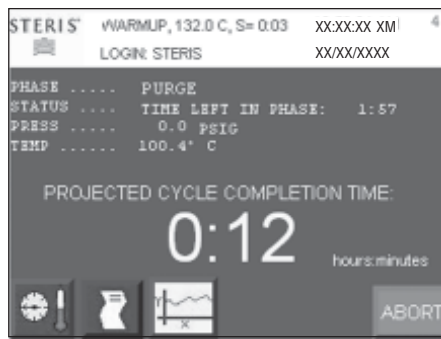

Screen #4

**PURGE PHASE:** Steam enters chamber from jacket to control pressure at 6 psig. Fast exhaust and water ejector is on to aid in removing air from chamber. After purge time, the following display appears:

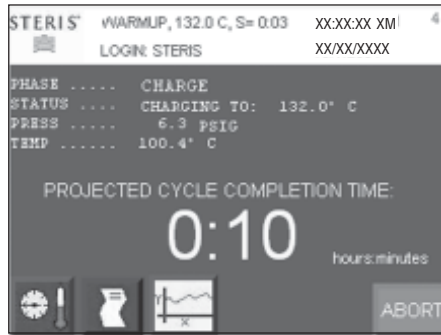

Screen #4

**CHARGE PHASE:** Chamber charges with steam until chamber temperature reaches sterilize temperature. Waste temperature is controlled to maintain approximately 45.0°C (113.0°F). After phase is complete, the following screen appears:

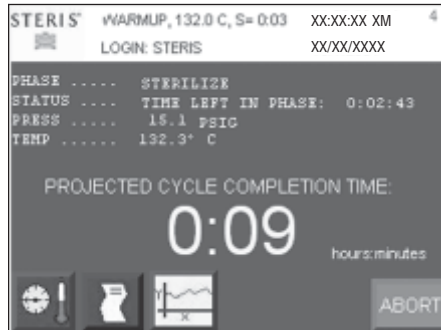

Screen #4

**STERILIZE PHASE:** Chamber temperature controls at sterilize temperature plus overdrive (control temperature). Waste temperature is controlled to maintain approximately 45.0° C (113.0° F). After sterilize time is complete, the following screen appears:



Screen #4

**FAST EXHAUST PHASE:** Steam fast exhausts from chamber to 4.0 psig (0.28 bar). After chamber pressure is less than 4.0 psig (0.28 bar), the following display appears:

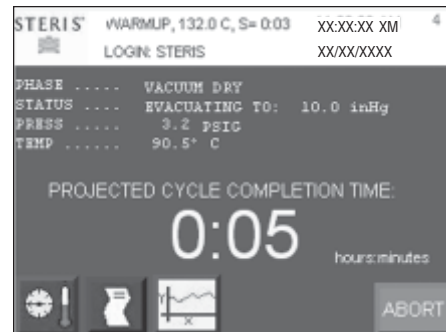

Screen #4

**VACUUM DRY PHASE:** A vacuum is pulled in chamber to 10.0 inHg (-0.34 bar) (VACUUM DRY setpoint). After chamber pressure is less than 10.0 inHg (-0.34 bar), the following display appears:

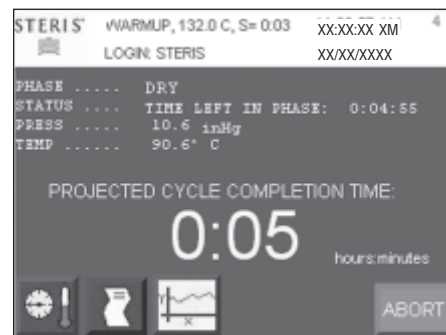

Screen #4

**DRY PHASE:** During dry phase, vacuum continues to be pulled to limit of system for dry time. After dry time, the following screen appears:



Screen #4

**AIR BREAK PHASE:** Chamber vacuum air breaks to 2.0 inHg (-0.17 bar). After chamber pressure is above 2.0 inHg (-0.17 bar), the following screen appears:

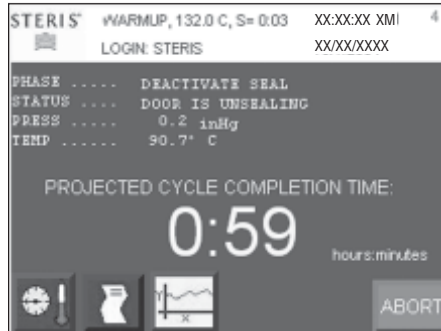

Screen #4

**DEACTIVATE SEAL PHASE:** Door unseals until seal pressure switch opens and 20 seconds has elapsed. After phase is complete, the following display appears:

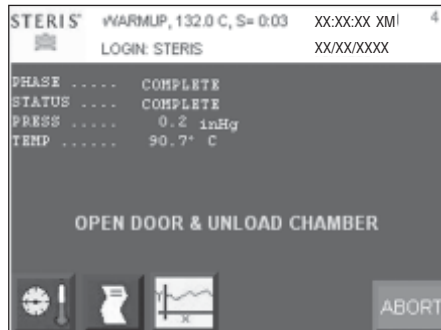

Screen #4

**COMPLETE PHASE:** Cycle is complete. Open door and unload chamber. Once door is open, display returns to main operating mode screen shown below:

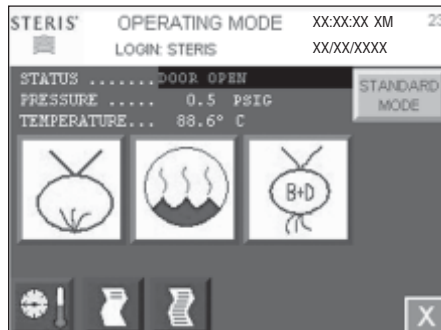

Screen #23

---

## **6.7 Bowie-Dick Cycle (Only On Prevacuum Sterilizers)**

---

Carefully review *SECTION 1, SAFETY PRECAUTIONS*, and below before operating sterilizer.



### **WARNING – BURN HAZARD:**

- Do not attempt to open the sterilizer door if a **WATER IN CHAMBER ALARM** condition exists. Call a qualified service technician before attempting to use sterilizer further.
- After manual exhaust, steam may remain inside the chamber. Always wear protective gloves, apron, and a face shield when following emergency procedure to unload sterilizer. Stay as far back from the chamber opening as possible when opening the door.
- Allow sterilizer to cool to room temperature before performing any cleaning or maintenance procedures.
- Failure to shut off the steam supply when cleaning or replacing strainers can result in serious injury.
- Jacket pressure must be 0 psig (0 bar) before beginning work on the steam trap.
- Proper testing of the safety valve requires the valve to be operated under pressure. Exhaust from the safety valve is hot and can cause burns. Proper safety attire (gloves, eye protection, insulated overall) is required. Testing is to be performed by qualified service personnel only.
- When sterilizing liquids, to prevent personal injury or property damage resulting from bursting bottles and hot fluid, you must observe the following procedures:
  - Use LIQUID cycle only; no other cycle is safe for processing liquids.
  - Use only vented closures; do not use screw caps or rubber stoppers with crimped seal.
  - Use only Type 1 borosilicate glass bottles; do not use ordinary glass bottles or any container not designed for sterilization.
  - Do not allow hot bottles to be jolted; this can cause hot-bottle explosions. Do not move bottles if any boiling or bubbling is present.



**WARNING – EXPLOSION HAZARD:** This sterilizer is not designed to process flammable compounds.

The cycle is designed to document the removal of residual air from a sample challenge load.

Run a BOWIE-DICK CYCLE by pressing **B+D CYCLE** button from the following screen:

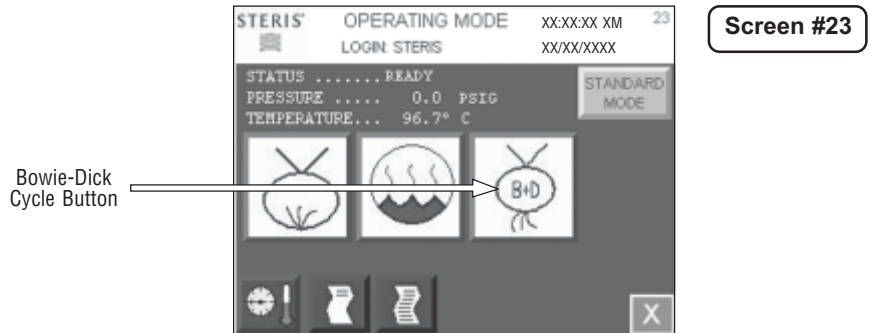

This screen is obtained by pressing the button on screen #2 or screen #19. The following display appears (see SECTION 5.3, STATUS BUTTONS, for description of buttons):



**JACKET CHARGE PHASE:** Jacket charge phase continues until jacket temperature is greater than 132.0°C (270.0°F). After jacket charge phase, the following display appears:

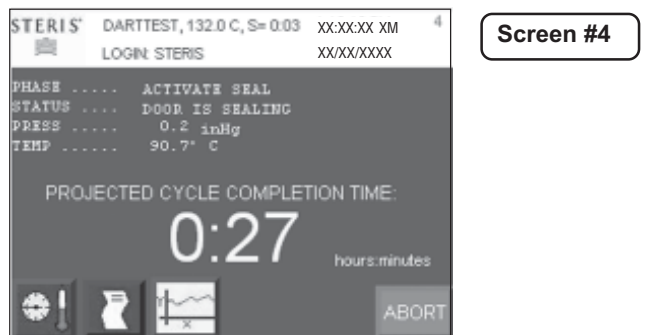

**ACTIVATE SEAL PHASE:** Door gasket seals with steam until door seal switch is closed. An additional 20 seconds elapses, after seal switch is closed, before phase is complete. After the activate seal phase, the following display appears:



Screen #4

**PURGE PHASE:** Steam enters chamber from jacket to control pressure at 6 psig. Fast exhaust and water ejector is on to aid in removing air from chamber. After purge time, the following display appears:



Screen #4

**PULSE EXHAUST PHASE:** Chamber exhausts to 4.0 psig (0.28 bar). Waste temperature is controlled to maintain approximately 45.0°C (113.0°F). Jacket temperature is controlled to maintain approximately 133.5°C (273.0°F) in jacket. After phase is complete, the following screen appears:



Screen #4

**PULSE EVACUATE PHASE:** Chamber evacuates to PULSE VACUUM setpoint (default 10.0 inHg (-0.34 bar) plus one minute. Waste temperature is controlled to maintain approximately 45.0°C (113.0°F). Jacket temperature is controlled to maintain approximately 133.5°C (273.0°F) in jacket. After phase is complete, the following screen appears:





Screen #4

**PULSE CHARGE PHASE:** Chamber charges with steam to PULSE CHARGE setpoint (default 26.0 psig (0.34 bar)). PULSE EXHAUST, PULSE EVACUATE, and PULSE CHARGE repeat for the number of pulses selected. After last PULSE EVACUATE phase is complete, the following screen appears:



Screen #4

**CHARGE PHASE:** Chamber charges with steam until chamber temperature reaches sterilize temperature. Waste temperature is controlled to maintain approximately 45.0°C (113.0°F). After phase is complete, the following screen appears:

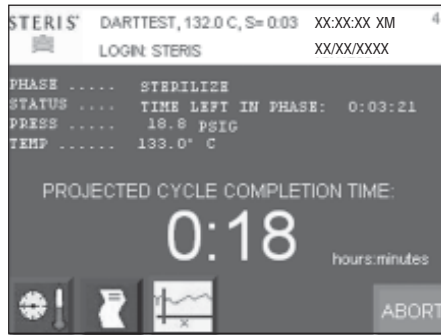

Screen #4

**STERILIZE PHASE:** Chamber temperature controls at sterilize temperature plus overdrive (control temperature). Waste temperature is controlled to maintain approximately 45.0°C (113.0°F). After sterilize time is complete, the following screen appears:



Screen #4

**FAST EXHAUST PHASE:** Steam fast exhausts from chamber to 4.0 psig (0.28 bar). After chamber pressure is less than 4.0 psig (0.28 bar), the following display appears:



Screen #4

**VACUUM DRY PHASE:** A vacuum is pulled in the chamber to 10.0 inHg (- 0.34 bar) (VACUUM DRY setpoint). After chamber pressure is less than 10.0 inHg (-0.34 bar), the following display appears:



Screen #4

**DRY PHASE:** During dry phase, vacuum continues to be pulled to limit of system for dry time. After dry time, the following screen appears:



Screen #4

**AIR BREAK PHASE:** Chamber vacuum air breaks to 2.0 inHg (-0.17 bar). After chamber pressure is above 2.0 inHg (-0.17 bar), the following screen appears:



Screen #4

**DEACTIVATE SEAL PHASE:** Door unseals until seal pressure switch opens and 20 seconds has elapsed. After phase is complete, the following display appears:



Screen #4

**COMPLETE PHASE:** Cycle is complete. Open door and unload chamber. Once door is open, display returns to main operating mode screen shown below:

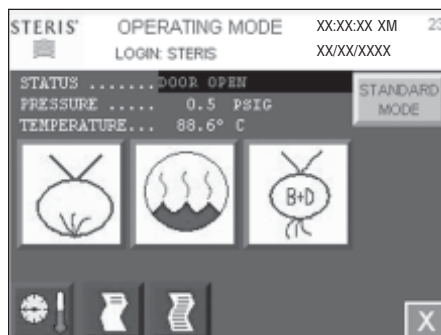

Screen #23

Carefully review *SECTION 1, SAFETY PRECAUTIONS*, and below before operating sterilizer.

## **6.8 Leak Test Cycle (Only On Prevacuum Sterilizers)**



### **WARNING – BURN HAZARD:**

- Do not attempt to open the sterilizer door if a **WATER IN CHAMBER ALARM** condition exists. Call a qualified service technician before attempting to use sterilizer further.
- After manual exhaust, steam may remain inside the chamber. Always wear protective gloves, apron, and a face shield when following emergency procedure to unload sterilizer. Stay as far back from the chamber opening as possible when opening the door.
- Allow sterilizer to cool to room temperature before performing any cleaning or maintenance procedures.
- Failure to shut off the steam supply when cleaning or replacing strainers can result in serious injury.
- Jacket pressure must be 0 psig (0 bar) before beginning work on the steam trap.
- Proper testing of the safety valve requires the valve to be operated under pressure. Exhaust from the safety valve is hot and can cause burns. Proper safety attire (gloves, eye protection, insulated overall) is required. Testing is to be performed by qualified service personnel only.
- When sterilizing liquids, to prevent personal injury or property damage resulting from bursting bottles and hot fluid, you must observe the following procedures:
  - Use LIQUID cycle only; no other cycle is safe for processing liquids.
  - Use only vented closures; do not use screw caps or rubber stoppers with crimped seal.
  - Use only Type 1 borosilicate glass bottles; do not use ordinary glass bottles or any container not designed for sterilization.
  - Do not allow hot bottles to be jolted; this can cause hot-bottle explosions. Do not move bottles if any boiling or bubbling is present.



**WARNING – EXPLOSION HAZARD:** This sterilizer is not designed to process flammable compounds.

**Important:** Before running a leak test cycle, the chamber temperature should be stabilized by running a normal cycle. A leak test cycle should be run on the sterilizer at least once each week. It should be one of the first cycles run for the day, but not the first cycle. In this cycle, the sterilizer automatically checks for vacuum leaks in the piping and door seal. If the sterilizer fails the leak test, it must be inspected by a service technician before using the sterilizer further. The leak test can be used to confirm that the sterilizer piping is intact after performing repairs.

**NOTE:** This test is not a substitute for a Dart test.

**NOTE:** The measured leak rate (mmHg/minute) is calculated by the control over a timed 10 minute period and is included in the cycle printout. A leak rate of 1 mmHg/minute is considered acceptable.

Run a LEAK TEST CYCLE by pressing **LEAK TEST** button from the following screen.

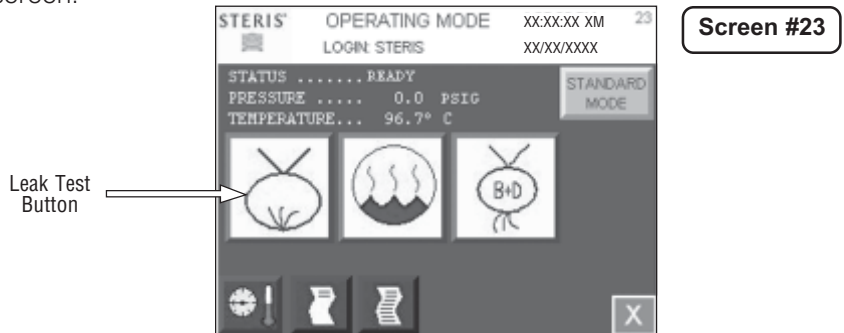

This screen is obtained by pressing **TEST MODE** button on screen #2 or screen #19. The following display is shown:

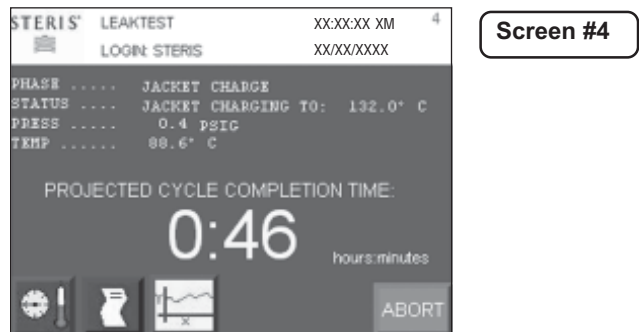

**JACKET CHARGE PHASE:** Jacket charge phase continues until jacket temperature is greater than 132.0°C (270.0°F). After jacket charge phase, the following display appears:

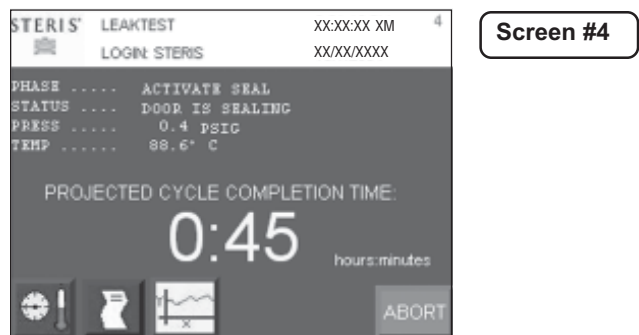

**ACTIVATE SEAL PHASE:** Door gasket seals with steam until door seal switch is closed. An additional 20 seconds elapses, after seal switch is closed, before phase is complete. After activate seal phase, the following display appears:

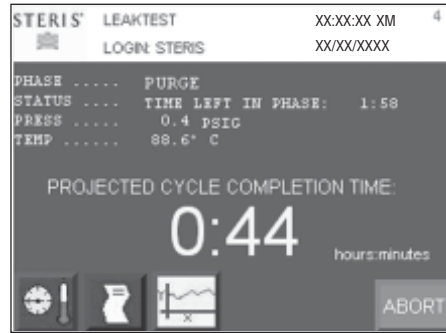

**Screen #4**

**PURGE PHASE:** Steam enters chamber from jacket to control pressure at 6 psig. Fast exhaust and water ejector is on to aid in removing air from chamber. After purge time, the following display appears:

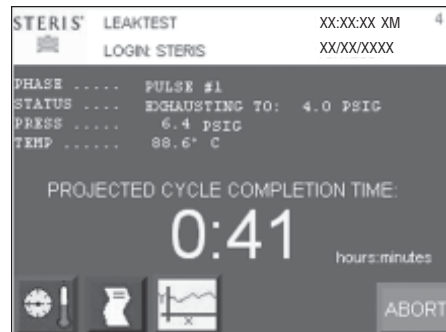

**Screen #4**

**PULSE EXHAUST PHASE:** Chamber exhausts to 4.0 psig (0.28 bar). Waste temperature is controlled to maintain approximately 45.0°C (113.0°F). Jacket temperature is controlled to maintain approximately 133.5°C (273.0°F) in jacket. After phase is complete, the following screen appears:



Screen #4

**PULSE EVACUATE PHASE:** Chamber evacuates to PULSE VACUUM setpoint (default 10.0 inHg (-0.34 bar). Waste temperature is controlled to maintain approximately 45.0°C (113.0°F). Jacket temperature is controlled to maintain approximately 133.5°C (273.0°F) in jacket. After phase is complete, the following screen appears:



Screen #4

**PULSE CHARGE PHASE:** Chamber charges with steam to PULSE CHARGE setpoint (default 26.0 psig (0.34 bar). PULSE EXHAUST, PULSE EVACUATE, and PULSE CHARGE repeat for the number of pulses selected. After last PULSE EVACUATE phase is complete, the following screen appears:

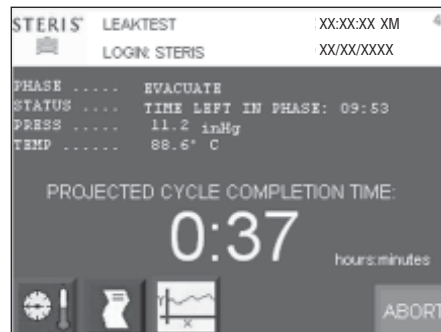

Screen #4

**EVACUATE PHASE:** Chamber evacuates for 10 minutes. Waste temperature is controlled to maintain approximately 45.0°C (113.0°F). After phase is complete, the following screen appears:

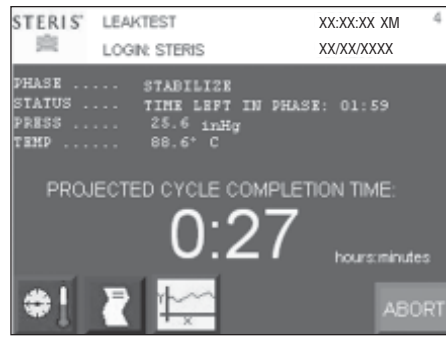

Screen #4

**STABILIZE PHASE:** Chamber remains in an idle state for two minutes (i.e., chamber holds at vacuum level). Waste temperature is controlled to maintain approximately 45.0°C (113.0°F). After stabilize time is complete, the following screen appears:

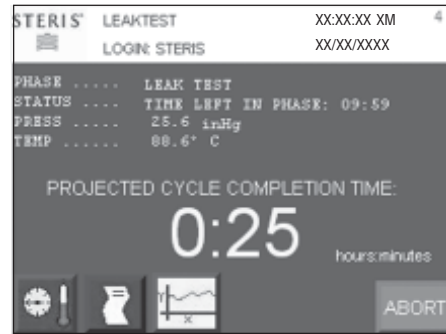

Screen #4

**LEAK TEST PHASE:** Chamber holds for 10 minutes. Initial and final pressure values are recorded. Leak rate is determined in mmHg. After leak test time is complete, the following display appears:



Screen #4

**AIR BREAK PHASE:** Chamber vacuum air breaks to 2.0 inHg (-0.17 bar). After chamber pressure is above 2.0 inHg (-0.17 bar), the following screen appears:



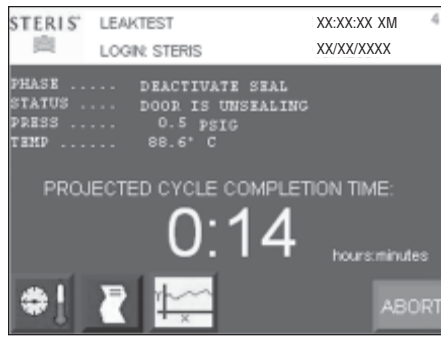

Screen #4

**DEACTIVATE SEAL PHASE:** Door unseals until seal pressure switch opens and 20 seconds has elapsed. After phase is complete, the following display appears:

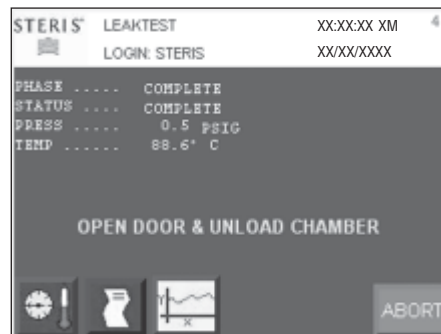

Screen #4

**COMPLETE PHASE:** The cycle is complete. Open the door. Once door is open, display returns to main operating mode screen shown below:

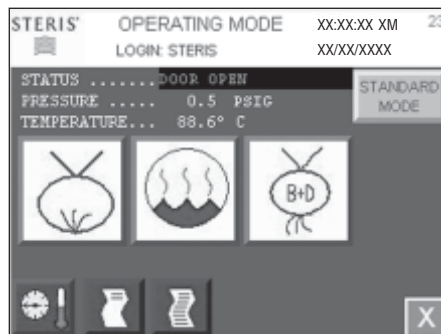

Screen #23

## 6.9 Cycle Abort

The cycle may abort for two reasons. The operator pressed the abort button or the cycle got an alarm that aborted the cycle. The following display is an example screen when the cycle is aborted.

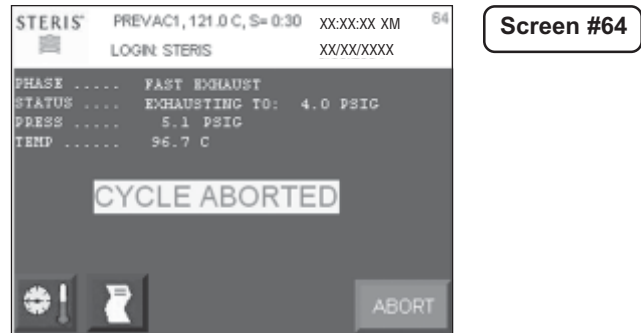

If the operator aborted the cycle, the printer prints

**\* CYCLE ABORTED BY OPERATOR**

The cycle aborts to the fast exhaust or slow exhaust phase. If the purge phase hasn't been run yet, cycle aborts to the deactivate seal phase.

If ABORT button is pressed on screen #64, the cycle ends and the screen shows operating mode screen #2 or #19. Cycle relieves any pressure in chamber.

---

## 6.10 Double Doors

---

If the sterilizer is equipped with double doors, there is an indicator light and unseal door button on the non-operating end door panel. The operating end door panel is provided with an unseal button on the display.

The indicator light is lit during cycle progress. The indicator is also lit whenever the door may not be unsealed. When the door is sealed, but may be unsealed, the indicator light blinks. Once the door is unsealed, the light turns off.

Press **UNSEAL DOOR** button to unseal door. Close door when completed loading or unloading chamber. Door automatically seals when operating door is unsealed.

See *SECTION 6.12.1, SUPERVISOR MODE - CYCLE PARAMETERS*, on the description of the interlock types.

---

## 6.11 Load Probe and F<sub>0</sub> Sterilization (Sterilizers With Load Probe Only)

---

The load probe and F<sub>0</sub> option equips the sterilizer with a load temperature probe (RTD) sealed through the chamber vessel. The probe is manually located by the operator in the product container within the chamber. In conjunction with this load probe option, the microcomputer control allows operator selection of two sterilization time measurement control modes. These modes are labeled: STER CTRL=DRAIN and STER CTRL=LOAD.

The DRAIN or **standard time at temperature** mode selection allows exposure time to be started from the temperature probe (RTD) located in the chamber drain line. Exposure time starts when drain line temperature is equal to or greater than chamber temperature setpoint, regardless of load temperature.

The LOAD or **equivalent time at sterilization temperature** mode selection allows exposure time to start when load probe located in the product and the chamber drain line probe reach a pre-set sterilize temperature. The F<sub>0</sub> value is calculated from the load probe located in the product load. Charge or exposure phase terminates when calculated F<sub>0</sub> value is equal to the pre-selected value, or if the sterilize time counts down to 0, whichever occurs first. The F<sub>0</sub> value and load temperature are printed along with standard status print values.

### 6.11.1 F<sub>0</sub> Sterilization

The F<sub>0</sub> is the measure of equivalent time at which a specific load would have been exposed at the base sterilization temperature of 121.0° C (250.0° F). Units of F<sub>0</sub> are minutes. The sterilizer control is programmed to calculate F<sub>0</sub> once all load probes have reached 110.0°C (230.0°F), although significant F<sub>0</sub> accumulation does not occur until all load probes are above 121.0°C (250.0°F), F<sub>0</sub> accumulates faster than real (clock) minutes.

The formula for F<sub>0</sub> is  $F_0 = \Sigma(10^{[(t1-t2)/Z]}) * \Delta t$

Where: t1 = Load temperature

t2 = 121.0° C (250.0° F)

Z = 10.0° C (18.0° F)

Δt = 1/60 minute (the time duration between F<sub>0</sub> accumulations per 1 minute)

See *SECTION 6.12.1, CYCLE PARAMETERS*, on the description of changing F<sub>0</sub> and STER CTRL values.

## 6.12 Separate Steam Feed Option

The separate steam feed option directs steam to jacket, while directing steam to chamber separately. The default method is to allow chamber steam to be fed from the jacket.

The separate steam feed option allows jacket temperature to be controlled independently from chamber temperature. Jacket temperature can be set for each individual cycle (see *SECTION 6.13.1, CYCLE PARAMETERS*).

## 6.13 Supervisor Mode

Refer to *SECTION 5, CONTROL INTERFACE*, for instructions on how to get to screen #6. The supervisor mode may be entered by pressing **SUPERVISOR** button on screen #6.

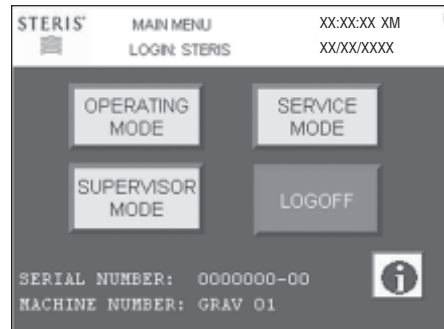

The following display is shown:

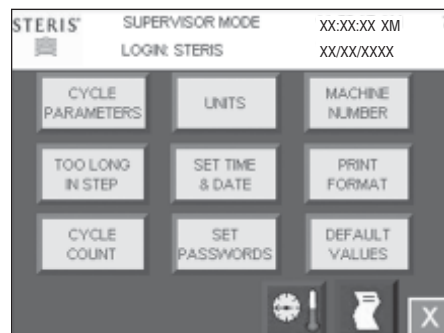

### 6.13.1 Cycle Parameters

Press **CYCLE PARAMETERS** on screen #7 to change or view cycle parameters. The following display is shown (gravity sterilizer):

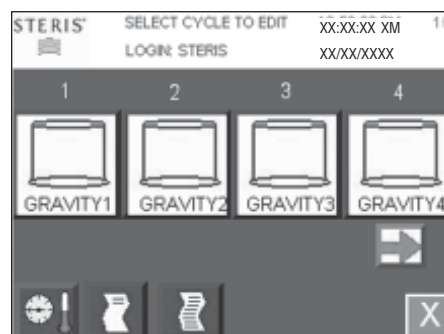

Press **PRINT CYCLE VALUES** button to print all of the cycle parameters. The following page shows an example print with defaulted cycle values for a prevac sterilizer.

```

=====
==== CYCLE VALUES PRINTOUT ====
=====
XX:XX:XX XM          XX/XX/XX

LOGIN NAME:  STERIS

1.PREVAC1
PURGE TIME= 2:00
  PULSES = 4
  PRES VAC = 10.0 inHg
  PRES CHG = 15.0 PSIG
STER TIME = 0:30:00
STER TEMP = 121.0°C
  OVERTEMP = 6.0°C
OVERDRIVE = 1.5 C
UNDERTEMP = 1.0°C RESUME
PRINT INT = 2 MIN
  VAC DRY = 10.0 inHg
  DRY TIME = 0:15:00
STRL CTRL = DRAIN
  Fo = 0
-----

2.PREVAC2
PURGE TIME= 2:00
  PULSES = 4
  PRES VAC = 10.0 inHg
  PRES CHG = 15.0 PSIG
STER TIME = 0:30:00
STER TEMP = 121.0°C
  OVERTEMP = 6.0°C
OVERDRIVE = 1.5 C
UNDERTEMP = 1.0°C RESUME
PRINT INT = 2 MIN
  VAC DRY = 10.0 inHg
  DRY TIME = 0:15:00
STRL CTRL = DRAIN
  Fo = 0
-----

3.PREVAC3
PURGE TIME= 2:00
  PULSES = 4
  PRES VAC = 10.0 inHg
  PRES CHG = 15.0 PSIG
STER TIME = 0:30:00
STER TEMP = 121.0°C
  OVERTEMP = 6.0°C
OVERDRIVE = 1.5 C
UNDERTEMP = 1.0°C RESUME
PRINT INT = 2 MIN
  VAC DRY = 10.0 inHg
  DRY TIME = 0:15:00
STRL CTRL = DRAIN
  Fo = 0
-----

4.PREVAC4
PURGE TIME= 2:00
  PULSES = 4
  PRES VAC = 10.0 inHg
  PRES CHG = 15.0 PSIG
STER TIME = 0:30:00
STER TEMP = 121.0°C
  OVERTEMP = 6.0°C
OVERDRIVE = 1.5 C
UNDERTEMP = 1.0°C RESUME
PRINT INT = 2 MIN

```

```

VAC DRY = 10.0 inHg
  DRY TIME = 0:15:00
STRL CTRL = DRAIN
  Fo = 0
-----

5.GRAVITY5
PURGE TIME= 2:00
STER TIME = 0:30:00
STER TEMP = 121.0°C
  OVERTEMP = 6.0°C
OVERDRIVE = 1.5 C
UNDERTEMP = 1.0°C RESUME
PRINT INT = 2 MIN
  VAC DRY = 10.0 inHg
  DRY TIME = 0:15:00
STRL CTRL = DRAIN
  Fo = 0
-----

6.GRAVITY6
PURGE TIME= 2:00
STER TIME = 0:30:00
STER TEMP = 121.0°C
  OVERTEMP = 6.0°C
OVERDRIVE = 1.5 C
UNDERTEMP = 1.0°C RESUME
PRINT INT = 2 MIN
  VAC DRY = 10.0 inHg
  DRY TIME = 0:15:00
STRL CTRL = DRAIN
  Fo = 0
-----

7.LIQUID7
PURGE TIME= 2:00
STER TIME = 0:45:00
STER TEMP = 121.0°C
  OVERTEMP = 6.0°C
OVERDRIVE = 1.5 C
UNDERTEMP = 1.0°C RESUME
PRINT INT = 2 MIN
STRL CTRL = DRAIN
  Fo = 0
-----

8.LIQUID8
PURGE TIME= 2:00
STER TIME = 0:45:00
STER TEMP = 121.0°C
  OVERTEMP = 6.0°C
OVERDRIVE = 1.5 C
UNDERTEMP = 1.0°C RESUME
PRINT INT = 2 MIN
STRL CTRL = DRAIN
  Fo = 0
-----

TOO LONG IN:
-----
ACTIVATE SEAL = 1 m
  AIR BREAK = 5 m
    CHARGE = 60 m
DEACTIVATE SEAL= 1 m
  EVACUATE = 30 m
    EXHAUST = 10 m
  JACKET CHARGE = 60 m

```

Screen #10 shows cycles 1 through 4. These cycles may be any combination of PREVAC, GRAVITY or LIQUID cycle type.

Press **RIGHT ARROW** button to change cycles 5 through 8. These cycles are shown on screen #36.

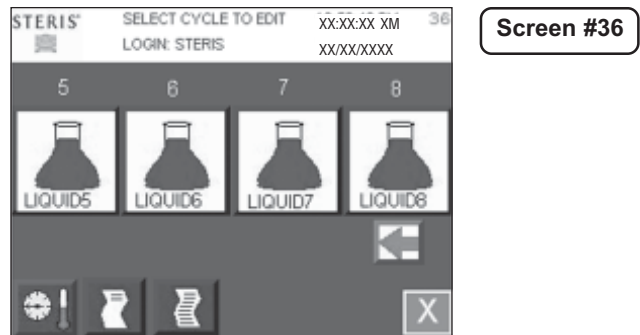

Press **LEFT ARROW** button to go back to screen #10. Press **GRAVITY** button to change cycle values on cycle 1 (*NOTE: This procedure may be applied for any cycle – some cycles may have less or more parameters*). The display then shows:

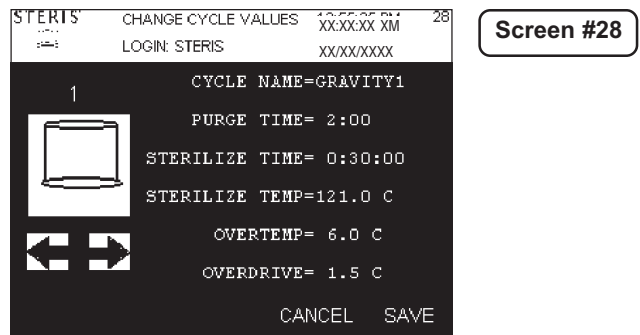

Values for cycle 1 may be changed on screen #28. Press **GRAVITY** button to change cycle type (either GRAVITY or LIQUID). On prevac machines, **PREVAC** button is shown. The following display is shown:

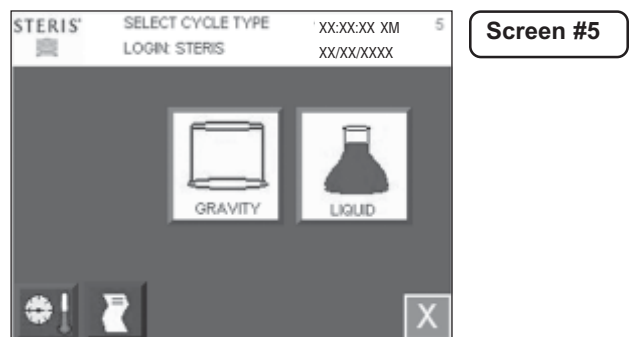

Press **LIQUID** button to set cycle to a liquid cycle type. Press **GRAVITY** button to set cycle to a gravity cycle type. On prevac sterilizers, press **PREVAC** button to set cycle to a prevac cycle type. The selected cycle type is shown on screen #28 or #32 for prevac cycles.

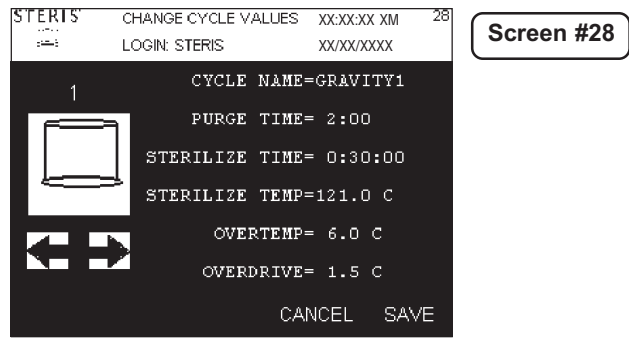

Screen #28 shows the gravity cycle type and the values changeable for the gravity cycle (*NOTE: When changing the prevac, isothermal, gravity and/or liquid cycles refer to this procedure*). Press **LEFT ARROW** and **RIGHT ARROW** buttons to scroll through the cycle values. Press **EXIT** button to return to screen #10.

**CYCLE NAME**

Press **CYCLE NAME=GRAVITY1** to change cycle name. The following display is shown:

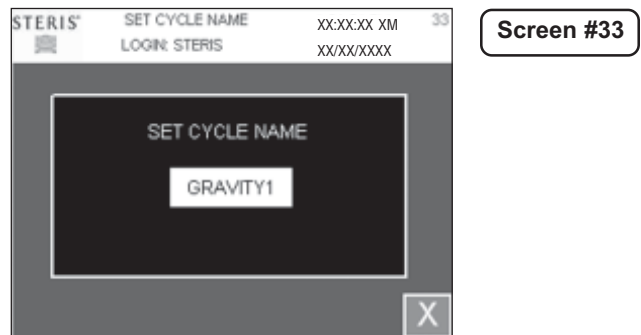

Press **WHITE** button with cycle name in it to change cycle name. An alphanumeric display is shown to enter cycle name. Enter any combination of numbers and letters and press **ENTER** button. The new cycle name is shown on screen #33. Press **EXIT** button to return to screen #28.

**PURGE TIME**

Press **PURGE TIME=2:00** to change the purge time. The following display is shown:



Press **WHITE** button next to minutes and seconds to change purge time. A numeric display is shown to enter purge time. The allowable range is 0 to 99 minutes and seconds. Enter numeric value and press **ENTER** button. New purge time is shown on screen #34. Press **EXIT** button to return to screen #28.

### PULSES (only on Prevacuum sterilizers)

Press **PULSES=4** to change number of pulses. The following display is shown:

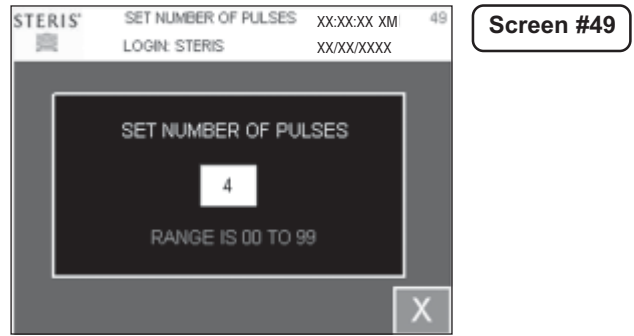

Press **WHITE** button to change number of pulses. A numeric display is shown to enter pulses. The allowable range is 0 to 99. Enter numeric value and press **ENTER** button. New pulses are shown on screen #49. Press **EXIT** button to return to screen #32.

### PULSE VACUUM (only on Prevacuum sterilizers)

Press **PULSE VACUUM=10.0** to change pulse vacuum value. The following display is shown:

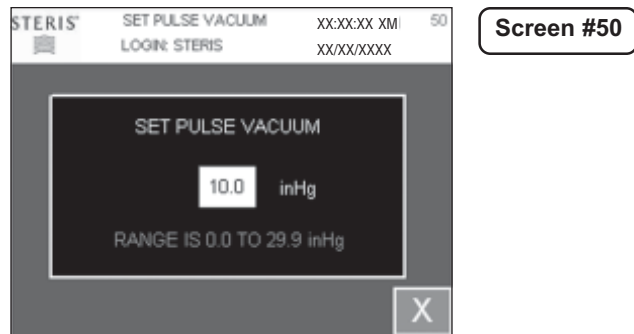

Press **WHITE** button to change the pulse vacuum. A numeric display is shown to enter pulse vacuum. The allowable range is 0 to 29.0 inHg. Enter numeric value and press **ENTER** button. New pulse vacuum is shown on screen #50. Press **EXIT** button to return to screen #32.

### PULSE CHARGE (only on Prevacuum sterilizers)

Press **PULSE CHARGE=15.0** to change pulse charge value. The following display is shown:

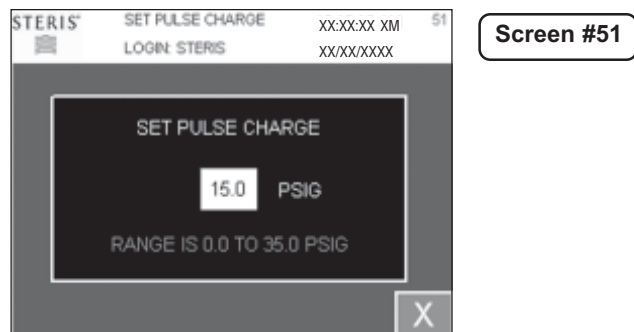



Press **WHITE** button to change pulse charge. A numeric display is shown to enter pulse charge. The allowable range is 0 to 35.0 psig. Enter numeric value and press **ENTER** button. New pulse charge is shown on screen #51. Press **EXIT** button to return to screen #32.

### STERILIZE TIME

Press **STERILIZE TIME=0:30:00** to change sterilize time. The following display is shown:



Press **WHITE** button next to the hours, minutes and seconds to change sterilize time. A numeric display is shown to enter sterilize time. The allowable range is 0 to 99 hours, minutes, and seconds. Enter numeric value and press **ENTER** button. New sterilize time is shown on screen #35. Press **EXIT** button to return to screen #28.

### STERILIZE TEMPERATURE

Press **STERILIZE TEMPERATURE=121.0°C** to change sterilize temperature. The following display is shown:

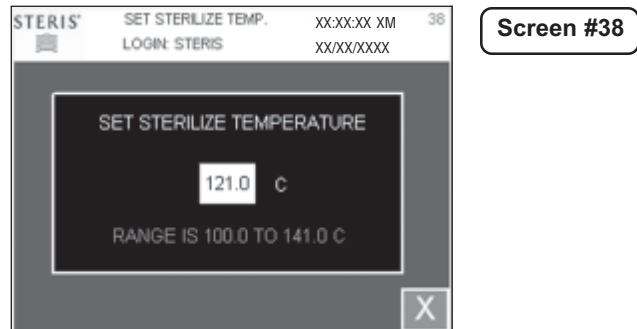

Press **WHITE** button to change sterilize temperature. A numeric display is shown to enter sterilize temperature. The allowable range is 100.0°C (212.0°F) to 141.0°C (285.0°F) for prevac, gravity, and liquid cycles. The allowable range is 78.0°C (172.0°F) to 110.0°C (230.0°F) for isothermal cycles. Enter numeric value and press **ENTER** button. New sterilize temperature is shown on screen #38. Press **EXIT** button to return to screen #28.

## OVERTEMP

Press **OVERTEMP=6.0°C** to change over temperature alarm setpoint. See *SECTION 7, ALARMS*, for explanation of over temperature alarm. The following display is shown:

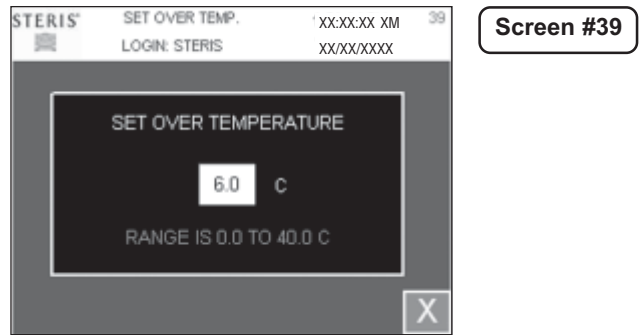

Press **WHITE** button to change overtemp. A numeric display is shown to enter overtemp. The allowable range is 0.0°C (32.0°F) to 40.0°C (104.0°F). Enter numeric value and press **ENTER** button. New sterilize temperature is shown on screen #39. Press **EXIT** button to return to screen #28.

## OVERDRIVE

Press **OVERDRIVE=1.5°C** to change overdrive (sterilize temperature + overdrive = control temperature). See sterilize phase in cycle for an explanation of control temperature. The following display is shown:

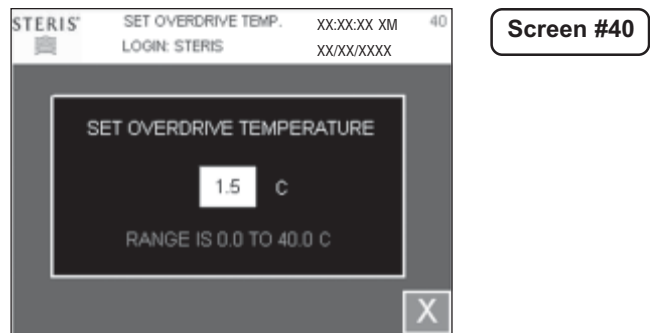

Press **WHITE** button to change overdrive. A numeric display is shown to enter overdrive. The allowable range is 0.0°C (32.0°F) to 40.0°C (104.0°F). Enter numeric value and press **ENTER** button. The new sterilize temperature is shown on screen #40. Press **EXIT** button to return to screen #28.

## UNDERTEMP

Press **UNDERTEMP=1.0°C** to change under temperature alarm setpoint. See ALARM SECTION for explanation of under temperature alarm. The following display is shown:

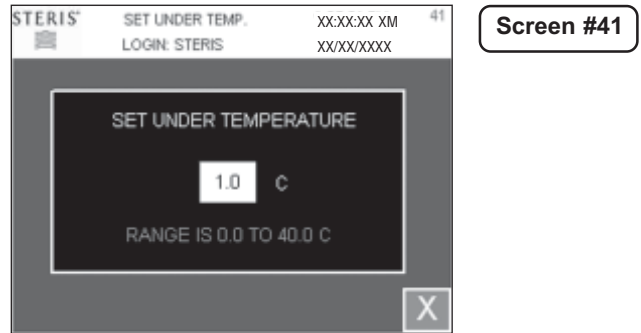

Press **WHITE** button to change undertemp. A numeric display is shown to enter undertemp. The allowable range is 0.0°C (32.0°F) to 40.0°C (104.0°F). Enter numeric value and press **ENTER** button. New sterilize temperature is shown on screen #41. Press **EXIT** button to return to screen #28.

## PRINT INTERVAL

Press **PRINT INT=2 MIN** to change the print interval setpoint. Print interval is the time interval of the status prints during sterilize phase. The following display is shown:

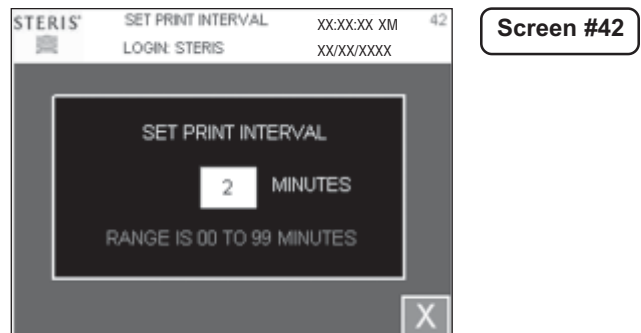

Press **WHITE** button to change print interval. A numeric display is shown to enter print interval. The allowable range is 0 to 99 minutes. Enter numeric value and press **ENTER** button. New sterilize temperature is shown on screen #42. Press **EXIT** button to return to screen #28.

## RESUME/RESTART

Press **RESUME/RESTART=RESUME** to set resume or restart setting. RESUME resumes sterilize timer after it has been stopped on an under temperature alarm. RESTART restarts sterilize timer after it has been stopped on an under temperature alarm. The following display is shown:

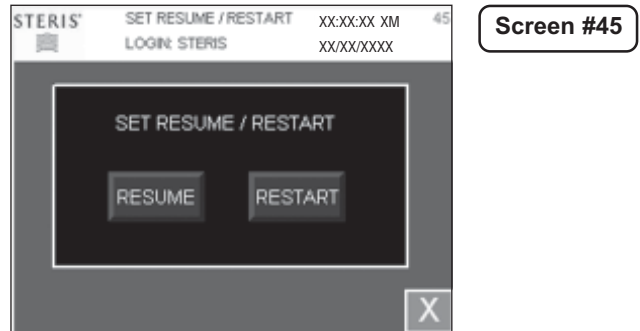

Press either **RESUME** or **RESTART** buttons to resume or restart. New resume or restart setting is shown on screen #28.

## VACUUM DRY

Press **VACUUM DRY=10.0 inHg (-0.34 bar)** to change vacuum dry setpoint. Vacuum dry setpoint is the vacuum level that dry timer starts. The following display is shown:



Press **WHITE** button to change vacuum dry setting. A numeric display is shown to enter vacuum dry setting. The allowable range is 0.0 to 29.9 inHg (1.0 -bar). Enter numeric value and press **ENTER** button. New vacuum dry setting is shown on screen #43. Press **EXIT** button to return to screen #28.

## DRY TIME

Press **DRY TIME=0:15:00** to change the dry time. The following display is shown:



Press **WHITE** button next to the hours, minutes, and seconds to change the dry time. A numeric display is shown to enter dry time. The allowable range is 0 to 99 hours, minutes, and seconds. Enter any numeric value and press **ENTER** button. New dry time is shown on screen #44. Press **EXIT** button to return to screen #32.

### JACKET TEMPERATURE (SEPARATE STEAM OPTION, ONLY)

Press **JACKET TEMPERATURE = 115.0°C** to change the jacket temperature. The following display appears:

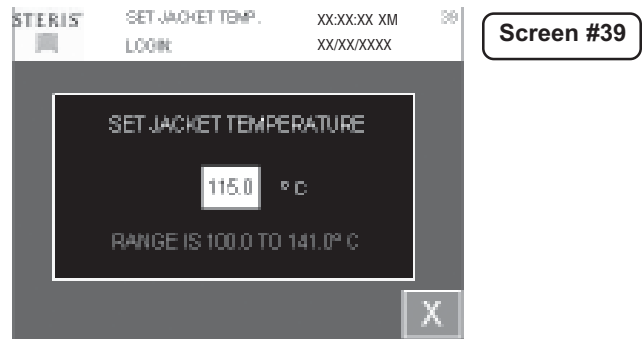

Press white button to change jacket temperature. A numeric display appears to enter jacket temperature. The allowable range is 100 to 141.0°C. The new jacket temperature is shown on screen #39. Press exit button to return to screen #35.

### STER CTRL (LOAD PROBE OPTION)

Press **STER CTRL=DRAIN** to set which temperatures the control uses to transition to sterilize phase. DRAIN option enters sterilize phase when chamber temperature reaches sterilize temperature. LOAD option enters sterilize phase when chamber and load temperature reaches sterilize temperature. Selecting LOAD option also enables  $F_0$  (See  $F_0$  cycle value). The following display is shown:

Press either **LOAD** or **DRAIN** buttons to resume or restart. New resume or restart setting is shown on screen #28.

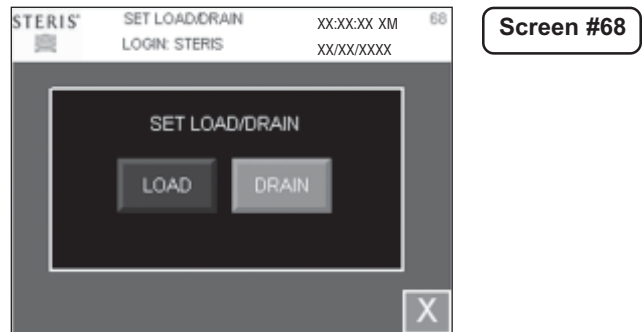

### $F_0$ (LOAD PROBE OPTION)

Press  **$F_0=0.0$**  to change the  $F_0$  value. Charge or sterilize phase ends when actual  $F_0$  value is equal to or greater than this setting. The following display is shown:

Press **WHITE** button to change  $F_0$  setting. A numeric display is shown to enter  $F_0$  setting. Enter numeric value and press **ENTER** button. New vacuum dry setting is shown on screen #69. Press **EXIT** button to return to screen #28.



### INTERLOCK DOORS (double door sterilizers only)

Press **INTERLOCK = DOOR B** button to change interlock type. The following display is shown:

There are four interlock types:

1. **NO INTERLOCKS** – Selected on screen above. Both doors are unsealed at the end of the cycle. Either door may be sealed or unsealed as many times as needed, out of cycle.

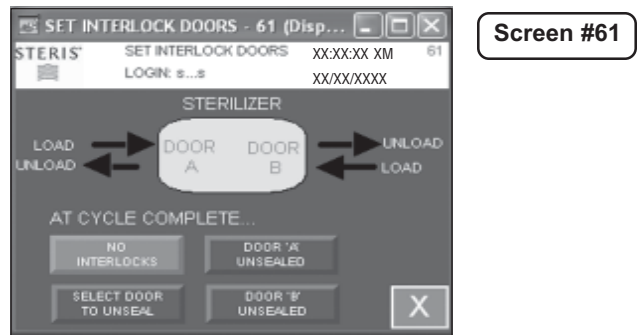

2. **SELECT DOOR TO UNSEAL** – At the end of the cycle, both doors remain sealed. Press unseal door button on same side as door to be unsealed. Door B is designated as the **sterile side**. Once door A is unsealed, door B may not be unsealed until a cycle is run.
3. **DOOR A UNSEALED** – At the end of the cycle, door A is unsealed. Press unseal door button on door A. Door B is designated as the **sterile side**. Once door A is unsealed, door B may not be unsealed until a cycle is run.
4. **DOOR B UNSEALED** – At the end of the cycle, door B is unsealed. Press unseal door button on door A. The door B is designated as the **sterile side**. Once door A is unsealed, door B may not be unsealed until a cycle is run.

From SUPERVISOR MODE screen #7, press **TOO LONG IN STEP** button to change or view the too long in step parameters. The following display is shown:

Press **LEFT ARROW** and **RIGHT ARROW** to scroll to other too long in step values not shown. Press **EXIT** to return to screen #7 (SUPERVISOR MODE).

### 6.13.2 Too Long In Step **ACTIVATE SEAL**

Press **ACTIVATE SEAL=1 MIN** to change the too long in activate seal value. The display shows screen #57. The following display is shown:

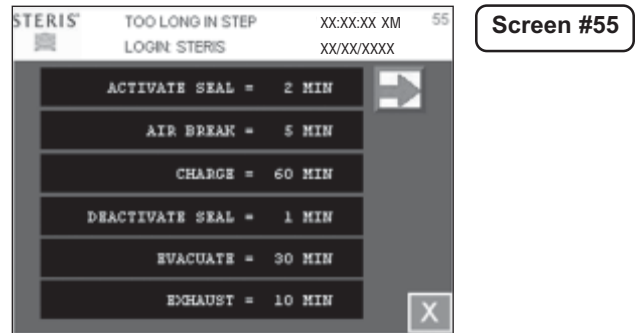

Press **WHITE** button to change too long in activate seal time. A numeric display is shown to enter value. Enter numeric value and press **ENTER** button. New value be shown on screen #57. Press **EXIT** button to return to screen #55.

#### **AIR BREAK**

Press **AIR BREAK=5 MIN** to change the too long in air break value. The display shows screen #62. The following display is shown:

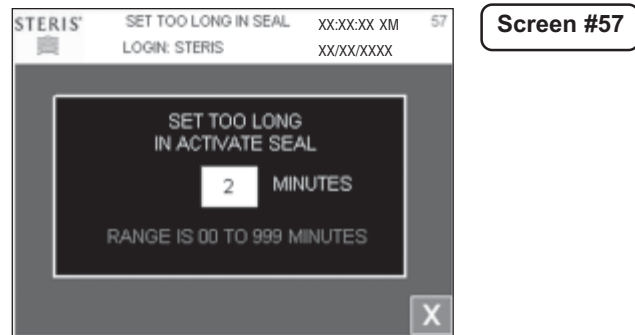

Press **WHITE** button to change too long in air break time. A numeric display is shown to enter value. Enter numeric value and press **ENTER** button. New value is shown on screen #62. Press **EXIT** button to return to screen #55.

#### **CHARGE**

Press **CHARGE=60 MIN** to change too long in charge value. The display shows screen #59. The following display is shown:

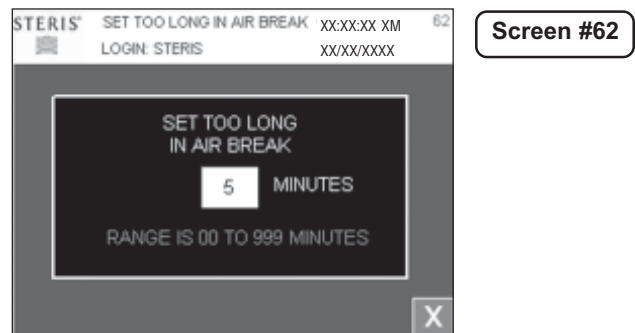

Press **WHITE** button to change the too long in charge time. A numeric display is shown to enter the value. Enter numeric value and press **ENTER** button. The new value is shown on screen #59. Press **EXIT** button to return to screen #55.

### DEACTIVATE SEAL

Press **DEACTIVATE SEAL=1 MIN** to change too long in deactivate seal value. The display shows screen #63. The following display is shown:

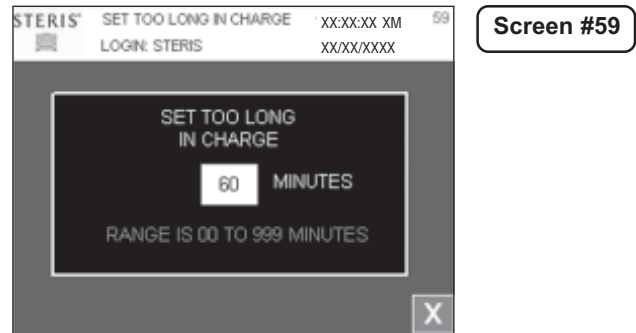

Press **WHITE** button to change too long in deactivate seal time. A numeric display is shown to enter value. Enter numeric value and press **ENTER** button. New value is shown on screen #63. Press **EXIT** button to return to screen #55.

### EVACUATE

Press **EVACUATE=30 MIN** to change too long in evacuate value. The display shows screen #60. The following display is shown:







Press **WHITE** button to change too long in evacuate time. A numeric display is shown to enter value. Enter numeric value and press **ENTER** button. The new value is shown on screen #60. Press **EXIT** button to return to screen #55.

### EXHAUST

Press **EXHAUST=10 MIN** to change too long in exhaust value. The display shows screen #58. The following display is shown:

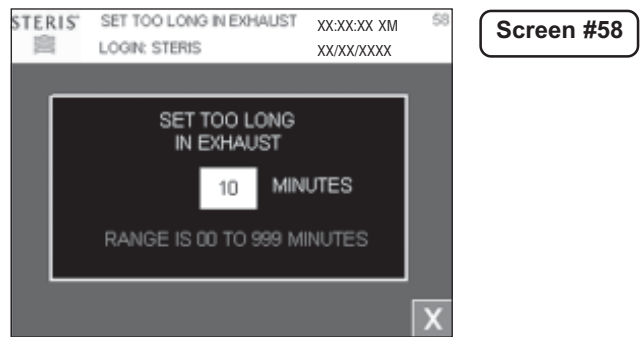

Press **WHITE** button to change too long in exhaust time. A numeric display is shown to enter value. Enter numeric value and press **ENTER** button. New value is shown on screen #58. Press **EXIT** button to return to screen #55.

### JACKET CHARGE

Press **JACKET CHARGE=60 MIN** to change the too long in exhaust value. The display shows screen #77. The following display is shown:

Press **WHITE** button to change too long in jacket charge time. A numeric display is shown to enter value. Enter numeric value and press **ENTER** button. The new value is shown on screen #77. Press **EXIT** button to return to screen

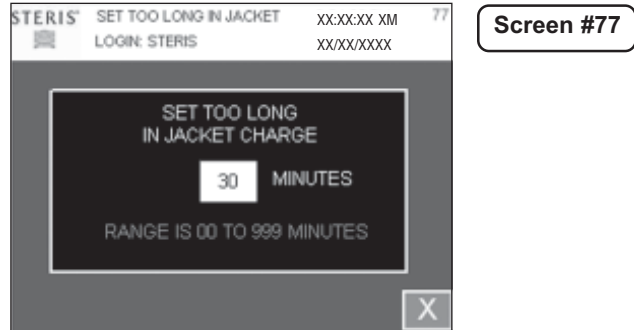

#55.

From SUPERVISOR MODE screen #7, press **CYCLE COUNT** button to change or view cycle count. The following display is shown:

### 6.13.3 Cycle Count

Press **WHITE** button to change cycle count. A numeric display is shown to enter value. Enter numeric value and press **ENTER** button. The new value

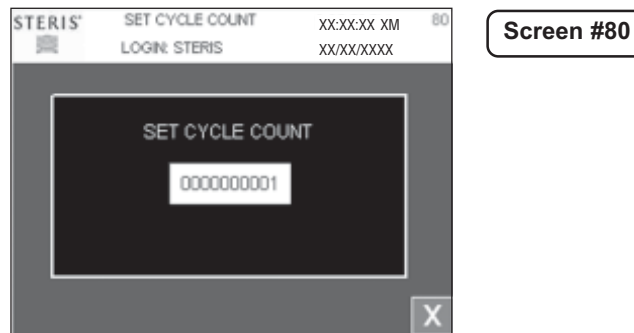

is shown on screen #80. Press **EXIT** button to return to screen #7.

### 6.13.4 Units

From SUPERVISOR MODE screen #7, press **UNITS** button to change or view the units. The following display is shown:

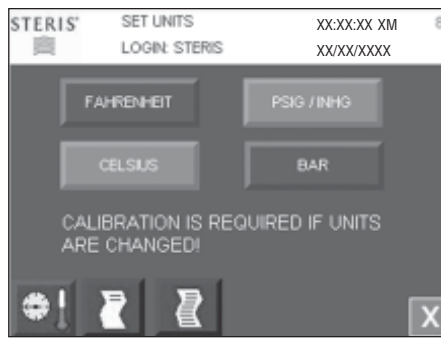

Screen #8

Press buttons to change units. A button highlighted in RED means unit is selected (i.e., CELSIUS and PSIG/INHG units are selected above). Press **EXIT** button to return to screen #7.

**6.13.5 Set Time and Date**

From SUPERVISOR MODE screen #7, press **SET TIME and DATE** button to change time and date. The following display is shown:

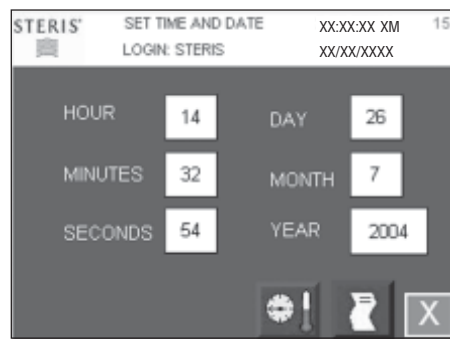

Screen #15

Enter time and date. Press **EXIT** button to return to screen #7.

**6.13.6 Set Passwords**

From SUPERVISOR MODE screen #7, press **SET PASSWORDS** button to set passwords. The following display is shown:



Screen #12

1. Press **LEFT ARROW** and **RIGHT ARROW** buttons to show additional user names and passwords. LEFT ARROW shows previous six user names and passwords, until it shows initial screen, then it shows last six user names and passwords. RIGHT ARROW shows next six user names and passwords, until it shows last screen, then it shows first six user names and passwords.

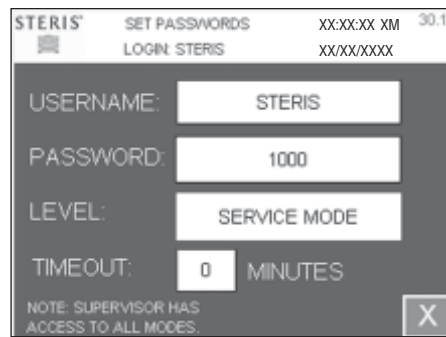

Screen #30.1

2. Press **SPACE 1** to change user name and password for (1). Press **SPACE 2** to add a user name and password for (2 – 12). The display shows the following screen:
3. Press **WHITE** box next to USERNAME to add a user name. An alphanumeric screen appears to enter value. Press **ENTER** button to save value and return to screen #30. The added user name is shown on the screen.
4. Press **WHITE** box next to PASSWORD to add a password corresponding to entered username. An alphanumeric screen appears to enter value.
5. Press **ENTER** button to save value and return to screen #30. The password is shown on the screen.
6. Press **WHITE** box next to LEVEL. The text changes to OPERATOR MODE, SUPERVISOR MODE, and SERVICE MODE. Select access level for username. Operator has access to operator mode only. Supervisor has access to operator mode and supervisor mode. Service mode has access to operator mode, supervisor mode, and service mode.
7. Press **WHITE** box next to TIMEOUT to set time out period (in minutes). A numeric screen appears to enter value.  
 Time out period is as follows: If user does not press a button in time out period, control logs out user and display shows screen #6. User then has to log back in. A value of 0 has no timeout.
8. Press **ENTER** button to save value and return to screen #30. Timeout time is shown on screen.
9. Press **ENTER** to save information and return to screen #12. New information is displayed on screen #12 where selected (i.e., if **4 button** was selected, the information is displayed there).
10. Press **EXIT** to exit set passwords screen and display screen #7 (supervisor mode screen).

### 6.13.7 Machine Number

From SUPERVISOR MODE screen #7, press **MACHINE NUMBER** button to view or change machine number. The following display is shown:

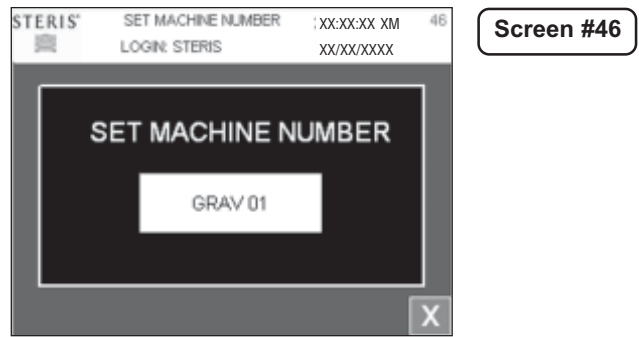

Press **WHITE** button to change machine number. A numeric display is shown to enter value. Enter numeric value and press **ENTER** button. New value is shown on screen #46. Press **EXIT** button to return to screen #7.

### 6.13.8 Default Values

From SUPERVISOR MODE screen #7, press **DEFAULT VALUES** button reset to default values. The following display is shown:

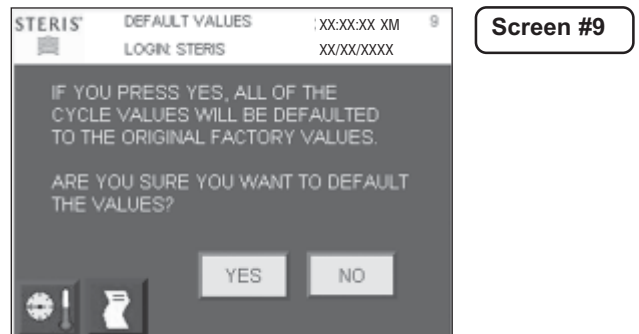



Press **YES** button to default all values (cycle values, too long in step, units, machine number and cycle count). Calibration values are not defaulted. Press **NO** button to cancel default values. Display returns to screen #7.

This section pictorially lists and describes all the possible alarm conditions which may occur when operating the Lab 250 and Lab 110 Life Sciences Small Sterilizers.

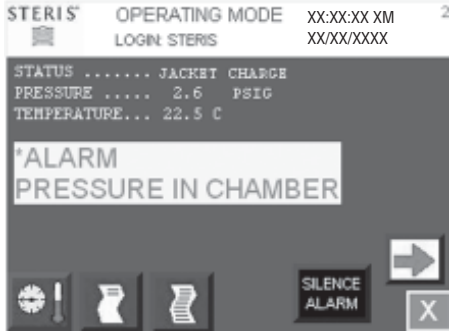
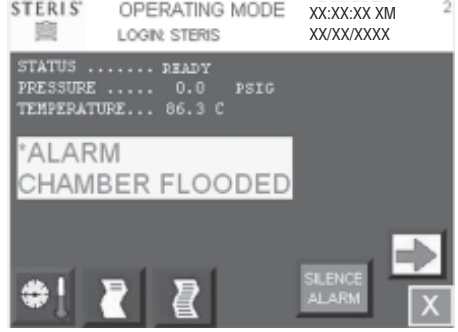

If a problem occurs that is not described in this section, please call your STERIS Service Representative. A trained service technician will promptly place your sterilizer in proper working condition.

When an alarm occurs the printer automatically generates a printout, typically listing alarm name, time alarm occurred, current chamber status, and any associated sensor temperatures.

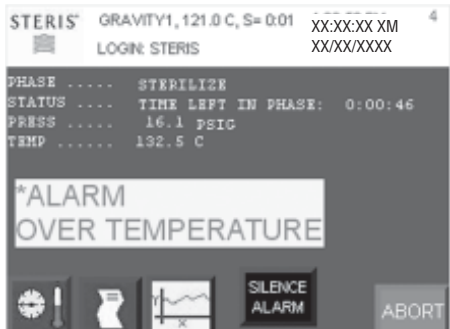
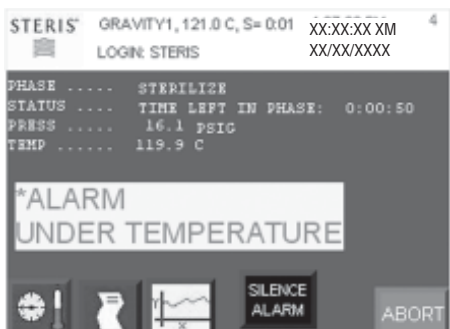
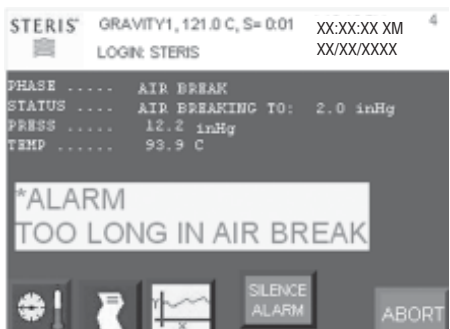

On the display, the alarm blinks. The alarm buzzer sounds an alarm. Press **SILENCE ALARM** button to silence the alarm



Alarm	Description	Screen with Alarm
<p>PRESSURE IN CHAMBER</p>	<p>Occurs if 2 psig (0.14 bar) pressure is sensed in the chamber when a cycle is not running.</p> <p style="text-align: right;"><b>Screen #2</b></p>	
<p>CHAMBER FLOODED</p>	<p>Occurs if excess water is sensed in the chamber.</p> <p><b>WARNING! BURN HAZARD CHAMBER MAY BE FILLED WITH STEAM CONDENSATE.</b></p> <p style="text-align: right;"><b>Screen #2</b></p>	
<p>DOOR SWITCH FAILURE</p>	<p>Occurs if door is sensed to be simultaneously sealed and opened.</p> <p style="text-align: right;"><b>Screen #2</b></p>	

Alarm	Description	Screen with Alarm
DOOR UNSEALED	Occurs if door is sensed to be unsealed during cycle.  <b>Screen #54</b>	
OVER TEMPERATURE	Occurs if the chamber temperature is greater than the sterilize temperature + overdrive + overtemp settings.  <b>Screen #49</b>	
UNDER TEMPERATURE	Occurs if the chamber temperature is less than the sterilize temperature – undertemp settings.  <b>Screen #4</b>	
TOO LONG IN AIR BREAK	Occurs if the air break phase is longer than the too long in air break setting.  <b>Screen #4</b>	

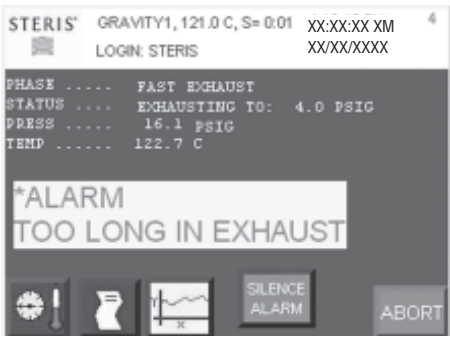
Alarm	Description	Screen with Alarm
<p>TOO LONG IN CHARGE</p>	<p>Occurs if the charge phase is longer than the too long in charge setting.</p> <p style="text-align: right;"><b>Screen #4</b></p>	 <p>The screenshot shows the STERIS Gravity1 interface. At the top, it displays 'STERIS GRAVITY1, 121.0 C, S= 0.01' and 'LOGIN: STERIS'. The current phase is 'CHARGE' and the status is 'CHARGING TO: 121.0 C'. The pressure is 0.2 inHg and the temperature is 22.5 C. A large red alarm banner reads '*ALARM TOO LONG IN CHARGE'. At the bottom, there are icons for a gauge, a person, a graph, and buttons for 'SILENCE ALARM' and 'ABORT'.</p>
<p>TOO LONG IN DOOR SEAL</p>	<p>Occurs if the activate seal phase is longer than the too long in door seal setting.</p> <p style="text-align: right;"><b>Screen #4</b></p>	 <p>The screenshot shows the STERIS Gravity1 interface. At the top, it displays 'STERIS GRAVITY1, 121.0 C, S= 0.01' and 'LOGIN: STERIS'. The current phase is 'ACTIVATE SEAL' and the status is 'DOOR IS SEALING'. The pressure is 0.2 inHg and the temperature is 93.9 C. A large red alarm banner reads '*ALARM TOO LONG IN SEAL'. At the bottom, there are icons for a gauge, a person, a graph, and buttons for 'SILENCE ALARM' and 'ABORT'.</p>
<p>TOO LONG IN DOOR UNSEAL</p>	<p>Occurs if the deactivate seal phase is longer than the too long in door unseal setting.</p> <p style="text-align: right;"><b>Screen #4</b></p>	 <p>The screenshot shows the STERIS Gravity1 interface. At the top, it displays 'STERIS GRAVITY1, 121.0 C, S= 0.01' and 'LOGIN: STERIS'. The current phase is 'DEACTIVATE SEAL' and the status is 'DOOR IS UNSEALING'. The pressure is 0.2 inHg and the temperature is 93.9 C. A large red alarm banner reads '*ALARM TOO LONG IN UNSEAL'. At the bottom, there are icons for a gauge, a person, a graph, and buttons for 'SILENCE ALARM' and 'ABORT'.</p>
<p>TOO LONG IN EVACUATE</p>	<p>Occurs if the evacuate phase is longer than the too long in evacuate setting.</p> <p style="text-align: right;"><b>Screen #4</b></p>	 <p>The screenshot shows the STERIS Gravity1 interface. At the top, it displays 'STERIS GRAVITY1, 121.0 C, S= 0.01' and 'LOGIN: STERIS'. The current phase is 'VACUUM DRY' and the status is 'EVACUATING TO: 10.0 inHg'. The pressure is 0.2 inHg and the temperature is 93.9 C. A large red alarm banner reads '*ALARM TOO LONG IN EVACUATE'. At the bottom, there are icons for a gauge, a person, a graph, and buttons for 'SILENCE ALARM' and 'ABORT'.</p>

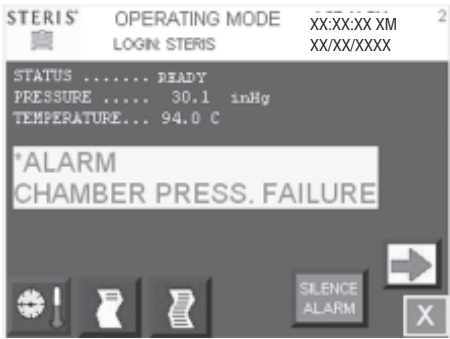

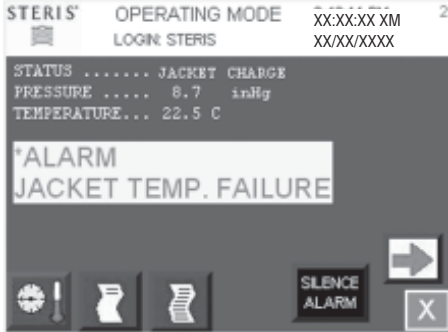
Alarm	Description	Screen with Alarm
<p>TOO LONG IN EXHAUST</p>	<p>Occurs if the exhaust phase is longer than the too long in exhaust setting.</p> <p style="text-align: right;"><b>Screen #4</b></p>	
<p>TOO LONG IN JACKET CHARGE</p>	<p>Occurs if the jacket charge phase is longer than the too long in jacket charge setting.</p> <p style="text-align: right;"><b>Screen #4</b></p>	
<p>CHAMBER TEMPERATURE FAILURE</p>	<p>Occurs if the chamber temperature RTD failed.</p> <p style="text-align: right;"><b>Screen #2</b></p>	
<p>CHAMBER PRESS. FAILURE</p>	<p>Occurs if the pressure transducer failed.</p> <p style="text-align: right;"><b>Screen #2</b></p>	

Alarm	Description	Screen with Alarm
JACKET TEMP. FAILURE	Occurs if the jacket temperature RTD failed. <div data-bbox="873 359 1024 401" style="border: 1px solid black; border-radius: 10px; padding: 2px; display: inline-block;">Screen #2</div>	
WASTE TEMP. FAILURE	Occurs if the waste temperature RTD failed. <div data-bbox="873 737 1024 779" style="border: 1px solid black; border-radius: 10px; padding: 2px; display: inline-block;">Screen #2</div>	
LOAD TEMP. FAILURE	Occurs if the load temperature RTD failed. <div data-bbox="873 1125 1024 1167" style="border: 1px solid black; border-radius: 10px; padding: 2px; display: inline-block;">Screen #2</div>	

## 8.1 Service Mode

Refer to *SECTION 5, CONTROL INTERFACE*, for instructions on how to get to screen #6. Press **SERVICE MODE** button on screen #6 to enter supervisor mode.

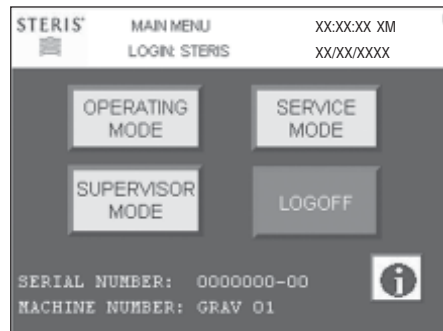

The following display appears:

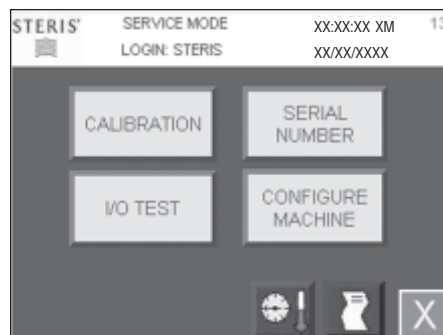

### 8.1.1 Calibration

Press **CALIBRATION** button to enter the calibration mode. The following display appears:

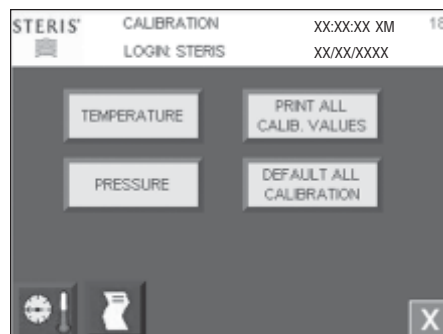

## TEMPERATURE CALIBRATION

Press **TEMPERATURE** button on screen #18 to enter the temperature calibration. The following display appears:

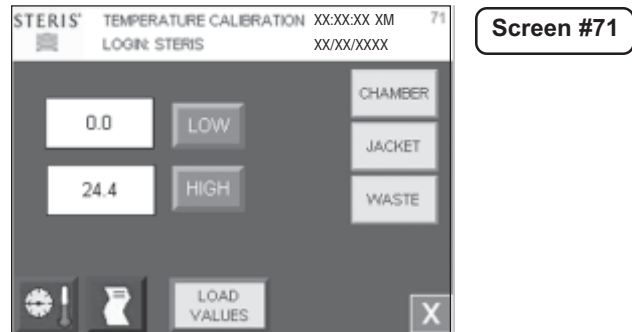

Select the temperatures to calibrate by pressing on buttons showing **CHAMBER**, **JACKET**, and **WASTE**. If all RTDs are selected to be calibrated, the screen is displayed as follows:

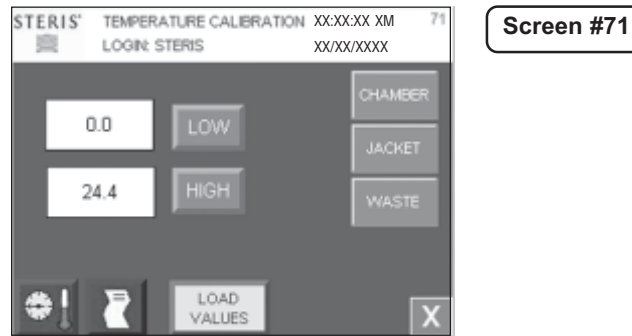

Place selected RTDs in a low temperature bath. This bath may be water or any other solution that would be lower in temperature than a high temperature bath. Place the calibrated reference probe in the bath. All of the probes should be as close together as possible so that they read the same temperature. After the RTDs have stabilized, (that is the calibrated reference temperature reading hasn't changed more than 0.1° over a one minute period), press **NUMERIC** button to the left of **LOW** button. Enter the calibrated reference temperature in the display. Press **LOW** button when complete. Verify temperatures are reading properly by pressing **PRESSURE/TEMP** button and reviewing screen #47:

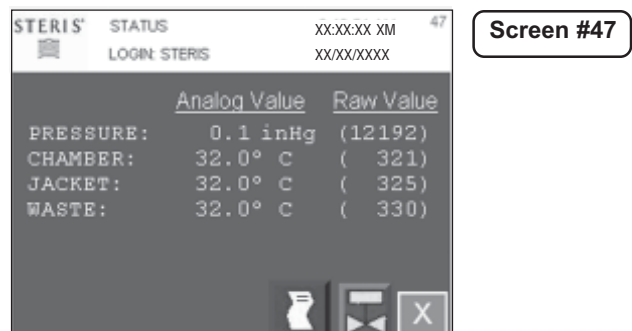

All selected temperatures should be exactly the same on screen #47. If they are not, return to screen #71 and press LOW button again. If they are bouncing:

- Check stability of bath
- Make sure RTDs are not touching bath container
- Check wiring connections on PLC
- Replace RTDs

After low temperature calibration point has been successfully completed, dry off RTDs and place them in high temperature oil bath (or equivalent). Place calibrated reference RTD with RTDs in oil bath.

After RTDs have stabilized, (that is the calibrated reference temperature reading hasn't changed more than 0.1° over a one minute period), press **NUMERIC** button to the left of **HIGH** button. Enter calibrated reference temperature in display. Press **HIGH** button when complete. Verify temperatures are all reading properly by pressing **PRESSURE/TEMP** button and reviewing the following screen:

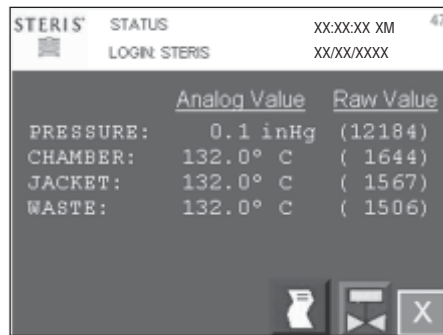

Screen #47

All selected temperatures should be exactly the same on screen #47. If they are not, return to screen #71 and press **HIGH** button again. If they are bouncing:

- Check stability of bath
- Make sure RTDs are not touching bath container
- Check wiring connections on PLC
- Replace RTDs

*NOTE: Actual low or high temperatures for the calibration are unimportant as long as the low is lower than the high. Typically, low bath is room temperature and high bath is highest sterilize temperature.*

## TEMPERATURE LOAD VALUES CALIBRATION

The temperature load values calibration is the method of re-entering the calibration values back into the PLC's memory. This may be necessary if the memory was altered because of a program download.

Press **LOAD VALUES** on the following screen:

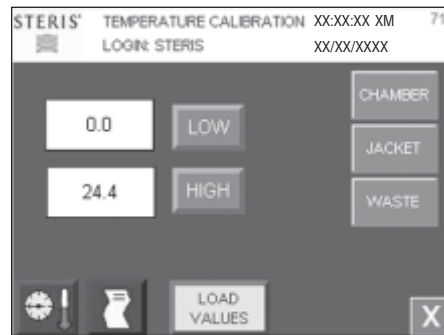

Screen #71

The display shows:

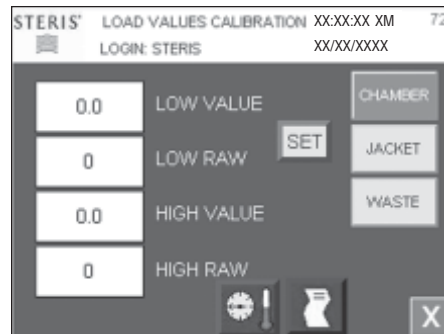

Screen #72

Press a **RTD** button to select it (chamber RTD is shown selected in the display above). Enter low, low raw, high, and high raw values in display. Press **SET** button when complete.

Press additional RTDs or press **EXIT** button to exit out.

## PRESSURE CALIBRATION

Press **PRESSURE** button on screen #18 to enter pressure calibration. The following display appears:



Screen #74

Open sterilizer door. Wait at least one minute. Press **WHITE** button next to the **LOW** button. Enter 0.0 in display. Press **LOW** button when complete (this saves low value). Press **PRESSURE/TEMP** button and verify pressure is 0.0. Return to screen #74. Press **SEAL DOOR** button to make it red. Wait 30 seconds. Press **PURGE** button to make it red. Wait two minutes. Press **HIGH POINT** button to make it red. Wait until pressure stabilizes at high point.

After pressure has stabilized for one minute (+/- 0.3 psi or better), press white button next to HIGH button. Enter calibrated reference pressure value in the display (example 35.0 psig). Press HIGH button when complete (this saves high value). Press **PRESSURE/TEMP** button and verify pressure is same as value just entered. Return to screen #74. Press **EVACUATE** button. Wait until pressure has stabilized at low vacuum setting. After pressure has stabilized for one minute (+/- 0.3 psi or better), press **WHITE** button next to **VAC MUL** button. Enter calibrated reference pressure value in the display (example 28.9 inHg). Press **VAC MUL** when complete (this saves vacuum value). Press **PRESSURE/TEMP** button and verify vacuum is same as value just entered. Press **AIR BREAK** button to break vacuum in the chamber and return to atmosphere. Press **UNSEAL DOOR** button to unseal the door. Press **COMPLETE** button after door is unsealed.

### PRESSURE LOAD VALUES CALIBRATION

Pressure load values calibration is the method of re-entering calibration values back into PLC's memory. This may be necessary if memory was altered because of a program download.

Press **LOAD VALUES** on following screen:

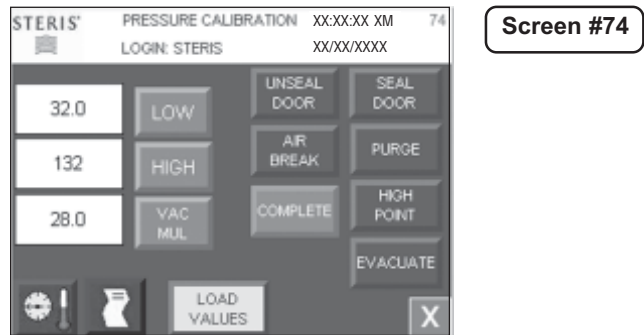

The display shows:

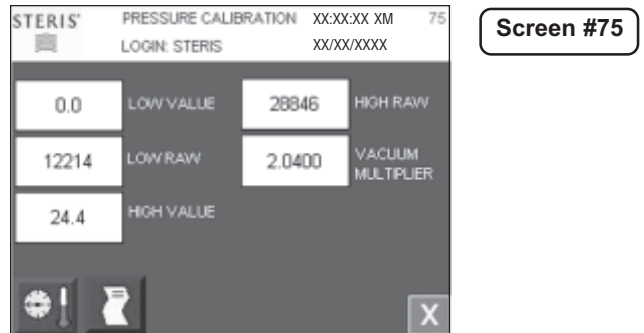

Enter low, low raw, high, high raw, and vacuum multiplier values. Press **EXIT** button when complete.

## PRINT CALIBRATION VALUES

Press PRINT ALL CALIBRATION VALUES button to print calibrated temperature and pressure values. The following prints (default values printed):

```
=====
===== CALIBRATION VALUES =====
=====
9/30/2004 9:16:44 AM

LOGIN: STERIS

PRESSURE
-----
LOW = 0.0
LOW RAW = 12214
HIGH = 24.4
HIGH RAW = 28846
VAC MUL = 2.040000

CHAMBER
-----
LOW = 32.0
LOW RAW = 321
HIGH = 132.0
HIGH RAW = 1644

JACKET
-----
LOW = 32.0
LOW RAW = 321
HIGH = 132.0
HIGH RAW = 1567

WASTE
-----
LOW = 32.0
LOW RAW = 330
HIGH = 132.0
HIGH RAW = 1506
=====
```



## DEFAULT CALIBRATION VALUES

Press **DEFAULT ALL CALIBRATION** button to default calibration values back to factory settings. The following screen appears.

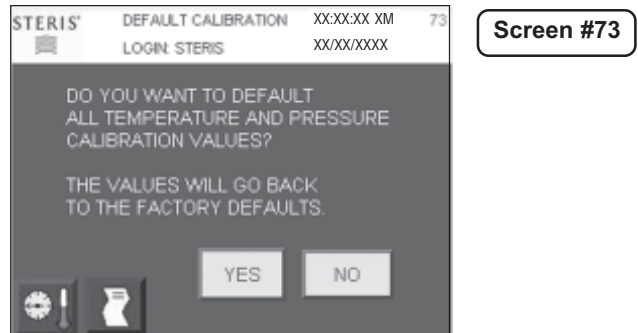

Press **YES** button to default calibration values to factory defaults. Press **NO** button to cancel defaulting calibration values and return to calibration menu.

### 8.1.2 I/O Test

Press **I/O TEST** button from the service mode screen to access input/output test. The following screen appears:

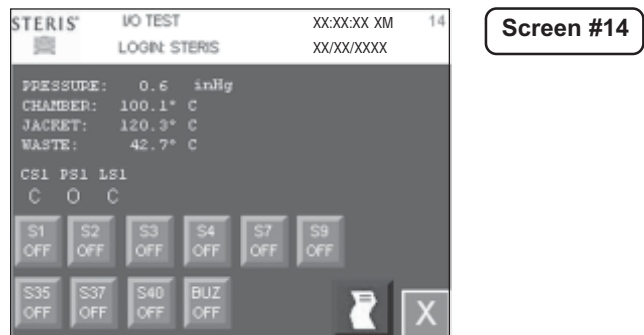

The display shows analog values, limit switches, and valves.

#### Limit switches:

- CS1 – chamber flooded limit switch
- PS1 – door **A** seal pressure switch
- PS2 – door **B** seal pressure switch (not shown – double doors only)
- LS1 – door **A** close switch
- LS2 – door **B** close switch

#### AC outputs:

- S1 – filtered air to chamber
- S2 – steam to chamber\*
- S3 – fast exhaust
- S4 – exhaust cooling
- S7 – water ejector
- S9 – steam to jacket
- S35 – door **A** seal steam
- S36 – door **B** seal (not shown – double doors only)\*\*
- S37 – door **A** seal exhaust
- S38 – door **B** seal exhaust (not shown – double doors only)

S08 – Isothermal steam to chamber\* (not shown – only on isothermal sterilizers)

S40 – constant bleed

BUZ- alarm and door open buzzer

ESG – electric steam to generator

\* if PS1 or PS2 open, then valve is off

\*\* if LS1 or LS2 open, then valve is off

Press valve button **S1 OFF** to turn valve on (red). Gray indicates valve is off. Each valve may be actuated on and off in this way.

Press **EXIT** button to exit I/O test screen and return to service mode screen. Any valve that shouldn't be on during normal operation is turned off automatically when exiting I/O test screen.

### 8.1.3 Serial Number

Press **SERIAL NUMBER** button on service mode screen to advance to set serial number screen. The screen is shown below:

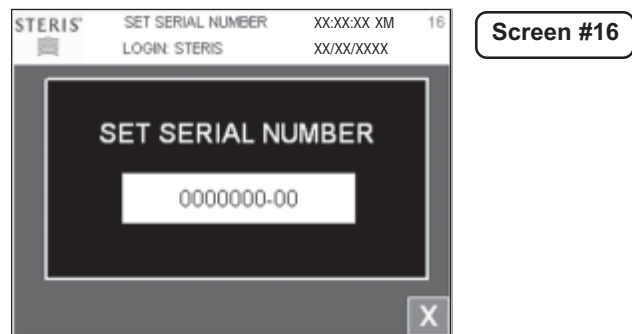

Press white box to set serial number. Enter serial number in the screen. Serial number is alphanumeric, and can be up to 12 characters. Press **EXIT** button when complete. Serial number is saved and screen returns to service mode screen.

### 8.1.4 Configure Machine

Press **CONFIGURE MACHINE** button to enter configuration mode. The following screen appears:

**WARNING—PERSONAL INJURY AND/OR EQUIPMENT DAMAGE HAZARD:**  
The configure machine section should only be done in the factory or by a qualified service technician.

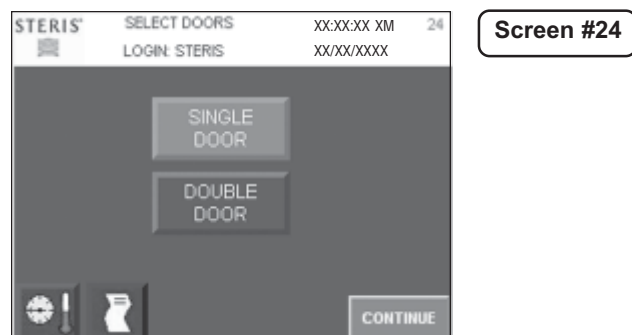

Select either single door or double door by pressing appropriate button. Red indicates option is selected. Make sure selection is correct based on machine type. Press **CONTINUE** button when complete. The following screen appears:

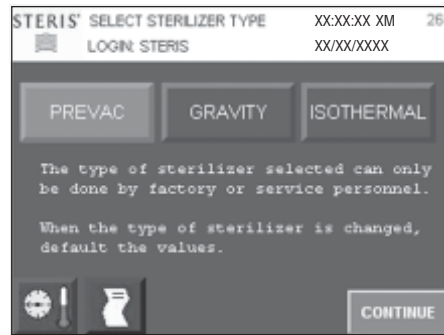

Screen #26

The display automatically shows correct sterilizer type. If sterilizer type is incorrect (i.e., GRAVITY is shown and it should be a PREVAC sterilizer), contact service. If sterilizer type is changed, values must be defaulted.

Press **CONTINUE** button when complete. The following screen appears:

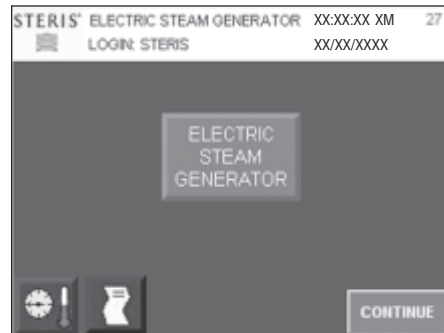

Screen #27

If sterilizer has an electric steam generator, press button to make it red; otherwise, button should stay blue. Press **CONTINUE** button when complete. The following screen appears:

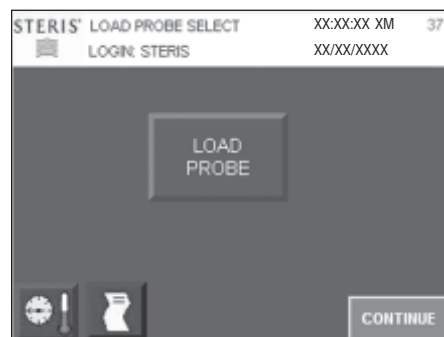

Screen #37

If sterilize has a load probe, press button to make it red, otherwise button should stay blue as shown above. Press **CONTINUE** button when complete. The following display appears:

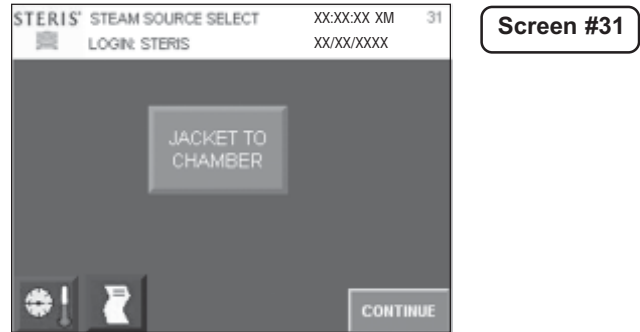

There are two different steam sources:

1. Jacket to chamber steam
2. Separate steam

The jacket to chamber steam source indicates steam going to chamber comes from jacket. The separate steam source means steam going to chamber comes directly from a generator or from house steam. The screen above shows jacket to chamber steam source selected. Press **SEPARATE STEAM** button to select separate steam source. Once selected steam source appears on the display, press **CONTINUE** button. The screen returns to service mode display. Press **EXIT** button to return to main menu.

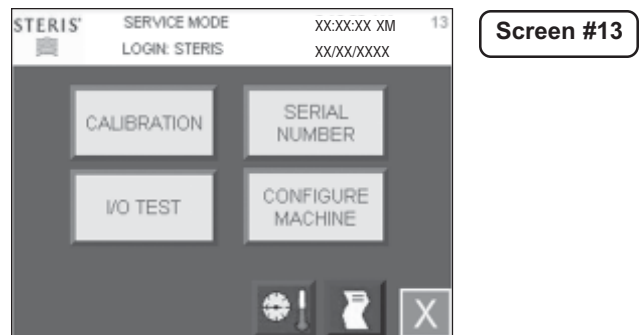

---

## 8.2 Change Printer Paper Roll (Cybertech Printer)

---

The printer paper roll should be changed whenever a colored strip is visible on one or both edges of the printout paper.

### PAPER LOADING:

1. Open front cover of printer to access paper compartment.
2. Tilt printer mechanism forward to access paper holder. See Figure 8.1 for the following steps.
3. Remove old paper core.
4. Notice loading diagram on back of printer case. Refer to this when loading paper.
5. Insert new paper into paper holder with loose end of paper placed into slot at top of print mechanism. Front panel LED should be flashing.
6. While holding paper in print mechanism, push front panel switch to **Feed** position (Up). Paper should feed into print mechanism and out the front. Refer to Figure 8.2.
7. Continue feeding paper until there is about eight inches of paper exiting print mechanism.
8. Guide paper between paper guide rod #1 and plastic window until it exits at top paper guide rod #2. Make sure paper goes around this guide correctly. Refer to Figure 8.3.
9. Make a slight bend in paper edge and place bent paper edge into slot on the take-up spindle. Hold paper on to paper spindle.
10. Push the front panel switch to **Feed** position, paper should then wrap around spindle. If this doesn't, remove paper and start at step 9 again.
11. Once take-up is loaded, push front panel switch to **Reprint** (down) position. This procedure starts a print cycle (test print or reprint).
12. Close front cover while print is taking place. This step keeps paper tight around take-up.

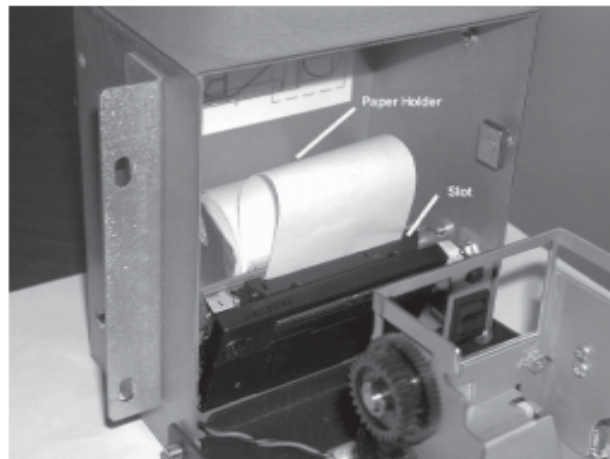

**Figure 8-1. Paper Compartment**

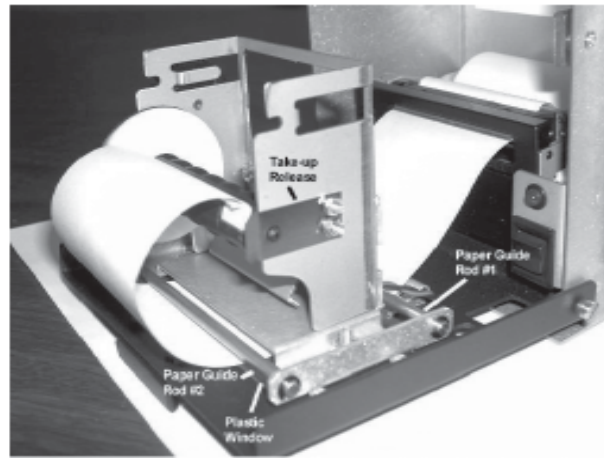

**Figure 8-2. Paper Feed Position**

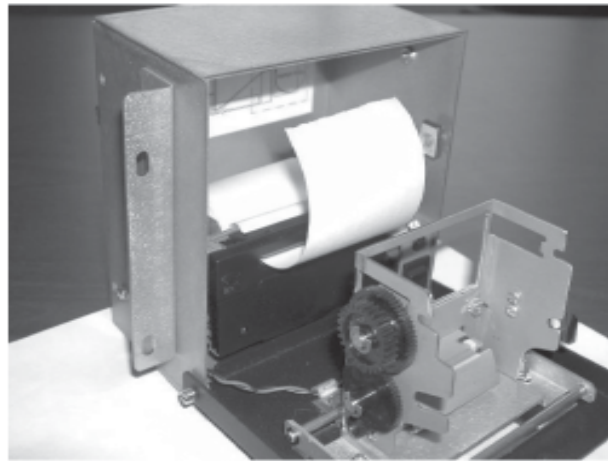

**Figure 8-3. Paper Guide**

• **TAKE-UP LOADING:**

1. When it is desired to remove stored paper from take-up, open front cover of printer.
2. While grasping take-up spindle and paper, push take-up release slightly to right until spindle is free. Refer to Figure 8-3 for take-up release position,
3. Simply slide paper off open end of take-up.
4. If paper does not release, rotate paper counter-clockwise, while holding spindle end bell. Then slide roll of paper off.
5. Replace spindle on to take-up.

---

## **8.3 Change Printer Paper Roll (Mylox Printer)**

---

To change the printer paper roll for the Mylox style printer, follow the steps given below.

1. Open the top cover of the printer and place the paper roll in position, observing the direction of the arrow indicated in Figure 8-4.
2. Insert the end of the roll into slit of print mechanism (see Figure 8-4); paper auto-loads after a slight delay.
3. In cases where auto-loading feature is not installed on the system, press FEED key (see Figure 8-4) so that a few centimeters of paper come out of the printer.
4. Insert the end into the slit on the top of the printer and close it.

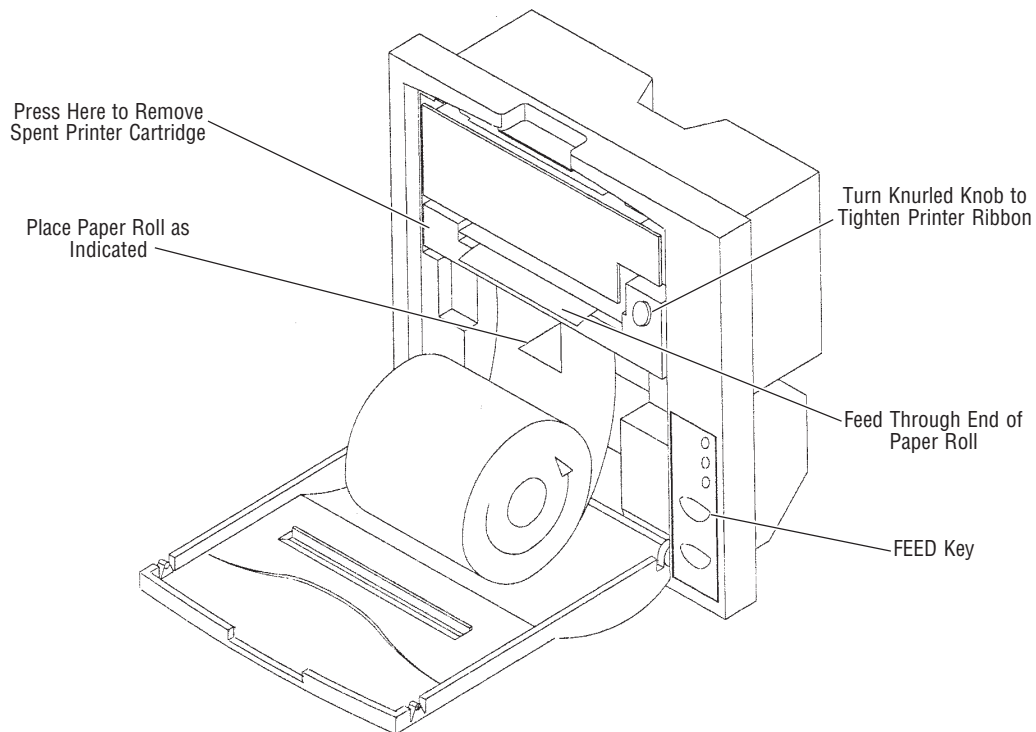

**Figure 8-4. Change Paper for Mylox-style Printer**

---

## **8.4 Change Printer Ribbon (Mylox Printer)**

---

1. Open the top of the printer and remove the old ribbon cartridge by pressing down at point indicated in Figure 8-4.
2. Insert the new ribbon, making sure that it is correctly positioned.
3. Pull the ribbon tight turning the knurled knob (see Figure 8-4), then close the printer's top again.



---

## 8.5 Clean Chamber Drain Strainer

---

**Important:** The chamber drain strainer must be cleaned at least once a day, preferably in the morning before running the first cycle.

1. Remove drain strainer from drain in bottom in chamber.
2. Remove any obvious debris from strainer. If necessary, clear screen in strainer using a brush, wire, or similar tool.
3. Once strainer has been cleared of obvious debris, reverse strainer under running water.
4. Replace strainer in chamber drain.

---

## 8.6 Flush Chamber Drain

---

Flush chamber drain as follows whenever line becomes clogged:

See warnings for cleaning chamber drain strainer.

1. Turn OFF steam supply valve. Wait until jacket pressure is zero. Wait until chamber has cooled to room temperature.
2. Remove chamber drain strainer. Clean strainer using procedures given above, if necessary.
3. Pour solution of 60 mL (~1/4 cup) of STERIS sonic detergent or Liqui-Jet 2 Instrument Detergent and 500 mL (~1 pint) of hot water into the drain. Solution may puddle in the bottom of the chamber.

... OR...

4. Should these detergents be unavailable, you may use a hot solution of 15 mL (~1 tablespoon) of tri-sodium phosphate to 500 mL (~1 pint) of hot water.
5. Open door and place strainer back in drain.

## 9.1 Maintenance Schedule

**⚠ WARNING-SHOCK AND BURN HAZARD:** Regularly scheduled preventive maintenance is required for safe and reliable operation of this equipment. Contact your STERIS Service Representative to schedule preventive maintenance.

**⚠ WARNING-PERSONAL INJURY OR EQUIPMENT DAMAGE HAZARD:** Repairs and adjustments to this equipment must be made only by fully qualified service personnel. Maintenance performed by inexperienced, unqualified persons or installation of unauthorized parts could cause personal injury or result in costly equipment damage.

Maintenance procedures described in this section must be performed regularly at indicated intervals, using maintenance schedule in **Table 9-1** as a guide. Local conditions (water quality, usage, etc.) may require more frequent maintenance than indicated. Refer to maintenance manual (purchased separately) for replacement parts lists.

Customer should maintain a record of all maintenance procedures performed on sterilizer.

If a problem occurs, refer to alarm section.

*NOTE: Never permit unqualified persons to service the sterilizer.*

**Table 9-1. Recommended Maintenance Schedule**

Service required	Minimum Frequency
1.0 PREPARATION FOR PREVENTIVE MAINTENANCE	
1.1 Discuss equipment with operators and check printouts.	6x per year
1.2 Follow appropriate safety procedures; prepare unit for preventive maintenance.	6x per year
2.0 DOOR ASSEMBLY (EACH DOOR ON A DOUBLE DOOR UNIT)	
2.1 Verify proper door and door proximity switch operation. Adjust switch(s), if needed.	6x per year
2.2 Check condition of door gasket for wear and tear. Replace, as needed	6x per year
3.0 VALVES	
3.1 Verify each hand valve operates smoothly, check valve packing for leaks, rebuild or replace, as needed. * Steam supply valve. * Water supply valve.	6x per year 6x per year
3.2 Replace check valves.	1x per year
3.3 Rebuild steam supply manifold.	1x per year
3.4 Rebuild all solenoid valves.	1x per year

Service required	Minimum Frequency
3.0 VALVES (Cont.) 3.5 Rebuild all check valves. 3.6 Rebuild steam control valve (PRV). 3.7 Verify proper setting/flow rate control valves. Replace, if needed. 3.8 Verify that safety valve is not leaking. 3.9 Replace safety valve.	 1x per year 1x per year 2x per year 6x per year 1x per year
4.0 MISC. PIPING COMPONENTS 4.1 Inspect steam strainer for debris. Clean, as needed. 4.2 Inspect water strainer for debris. Clean, as needed. 4.3 Inspect jacket strainer for debris. Clean, as needed. 4.4 Inspect chamber drain strainer for debris. Clean, as needed. 4.5 Replace air filter cartridge. 4.6 Chamber and jacket gauge(s) – verify proper operation. Replace, if needed. 4.7 Rebuild chamber and jacket traps. 4.8 Verify that there are no leaks. 4.9 Verify that door lock piston operates correctly.	 2x per year 2x per year 2x per year 6x per year 1x per year 6x per year 1x per year 6x per year 6x per year
5.0 CONTROL 5.1 Verify printer and paper take-up operate properly. Check printout for darkness, missing dots, etc. 5.2 Verify all touch panels function properly (O.E. and N.O.E.). 5.3 Verify date and time are correct. If not, correct. 5.4 Verify operation of battery backed RAM. Replace, as needed. 5.5 Verify buzzer is working. 5.6 Verify water level sensor operates properly. 5.7 Verify functional operation of each valve using the service mode I/O test. 5.8 Verify temperature with pressure displays/printouts. 5.9 Verify temperature and pressure settings.	 6x per year 6x per year 6x per year 6x per year 6x per year 6x per year 6x per year 6x per year 6x per year
6.0 SAFETY TESTING 6.1 Inspect ground bond. 6.2 Inspect steam connection to sterilizer. 6.3 Inspect water connection to sterilizer. 6.4 Inspect drain connection to sterilizer. 6.5 Test ground continuity to sterilizer per EN 61010-1.	 1x per year 1x per year 1x per year 1x per year 1x per year

Service required	Minimum Frequency
7.0 FINAL CHECKOUT AND TEST	
7.1 Clean dirt and lint from components. Check all wiring, terminals and socket connections for damage and fraying.	6x per year
7.2 Verify unit has proper labels (caution, warnings).	6x per year
7.3 Run machine through each cycle to verify proper operation. Check all displays and printouts. Note on tape, <b>STERIS TEST</b> .	6x per year
7.4 Reinstall any panel or cover removed. Check area to insure removal of all materials used during inspection.	6x per year

## 9.2 Spare Parts

To order replacement parts and/or supply products, proceed as follows:

1. Include description and part/order number as listed in the following table.
2. Include model and serial numbers of your sterilizer on your order.
3. Send your order directly to the sales and service center serving your area.

Contact your sales representative for recommendations on cleaning products, biological indicators, or parts that are not listed below.

*NOTE: Use only STERIS authorized parts on this equipment. Use of unauthorized parts void the warranty.*

### REPLACEMENT PARTS

Description	Part Number
-------------	-------------

#### Cybertech Printer

Replacement paper (box of 5)	P387352-558
Replacement ribbons (package of 5)	P387352-559

#### Mylox Printer

Replacement paper (box of 5)	P387352-558
Replacement ribbons (box of 2)	P150828-440

## 10.1 PLC Specifications

### PLC: MicroLogix® 1200 Controller\*

**Catalog number:** 1762-L24BWA

**Agency Certification:** UL 508, C-UL under CSA C222.2 no. 142, Class I, Div. 2, Groups A, B, C, D (UL 1604, C-UL under CSA C222.2 no. 213) and CE

**Operating temperature:** 0°C to 55°C (32°F to 131°F) ambient.

**Storage temperature:** -40° C to 85°C (-40° F to 185°F) ambient.

**Operating humidity:** 5% to 95% relative humidity (non-condensing)

**Variables stored in flash memory for permanent storage.**

Optional Memory module for program backup.

### ANALOG MODULE: 4 CHANNEL INPUT MODULE

**Catalog number:** 1762-IF4

**Resolution:** 15 bits (bipolar)

**Repeatability:** +/-0.1%

### RTD MODULE: 4 CHANNEL INPUT MODULE

**Catalog number:** 1762-IR4

**Resolution:** 0.1°C (0.1°F)

**Repeatability:** +/-0.2°C (+/- 0.4°F)

**Accuracy:** +/-0.9°C (+/- 1.62°F)

**Maximum drift:** +/-0.026°C/°C (+/- 0.026° F/°F)

### RELAY OUTPUT MODULE: 8 AC OUTPUTS

**Catalog number:** 1762-OW8

### DISPLAY: PANELVIEW PLUS® 600

**Catalog number:** 2711P-T6C20D

### COMMUNICATION MODE:

**Catalog number:** 2711P-RN22C

\* MicroLogix® 1200 Controller is a registered trademark of Rockwell Automation.